

Action Notes

Dialog

The time had come to test it.

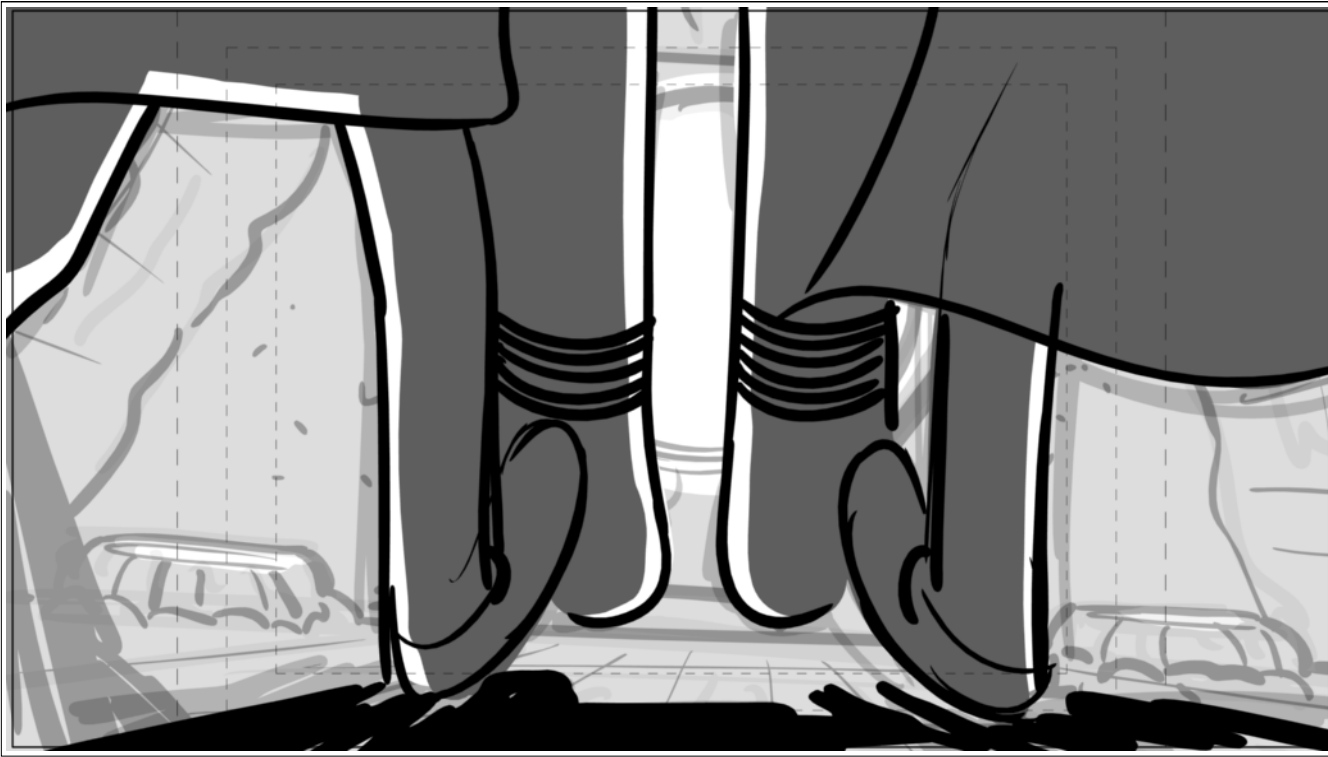

Action Notes

Dialog

The time had come to test it.

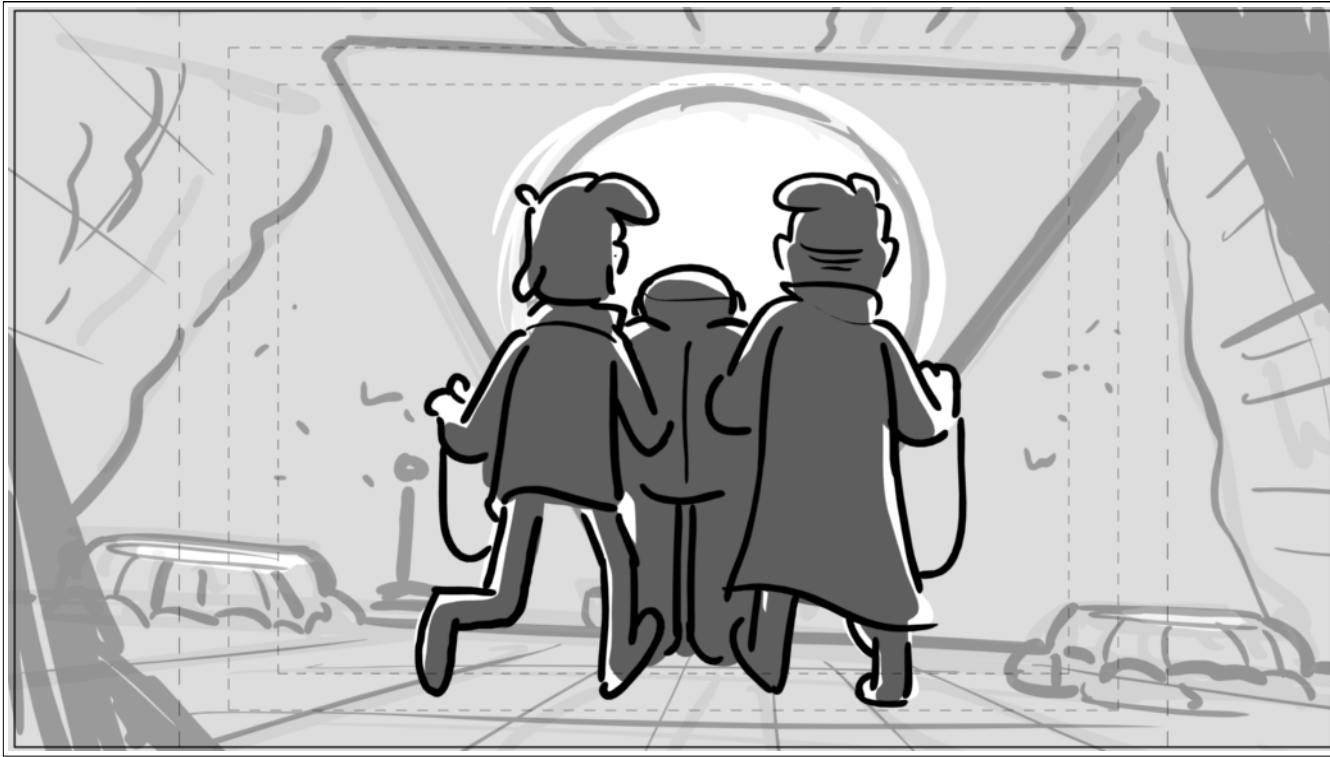

Action Notes

Dialog

The time had come to test it.

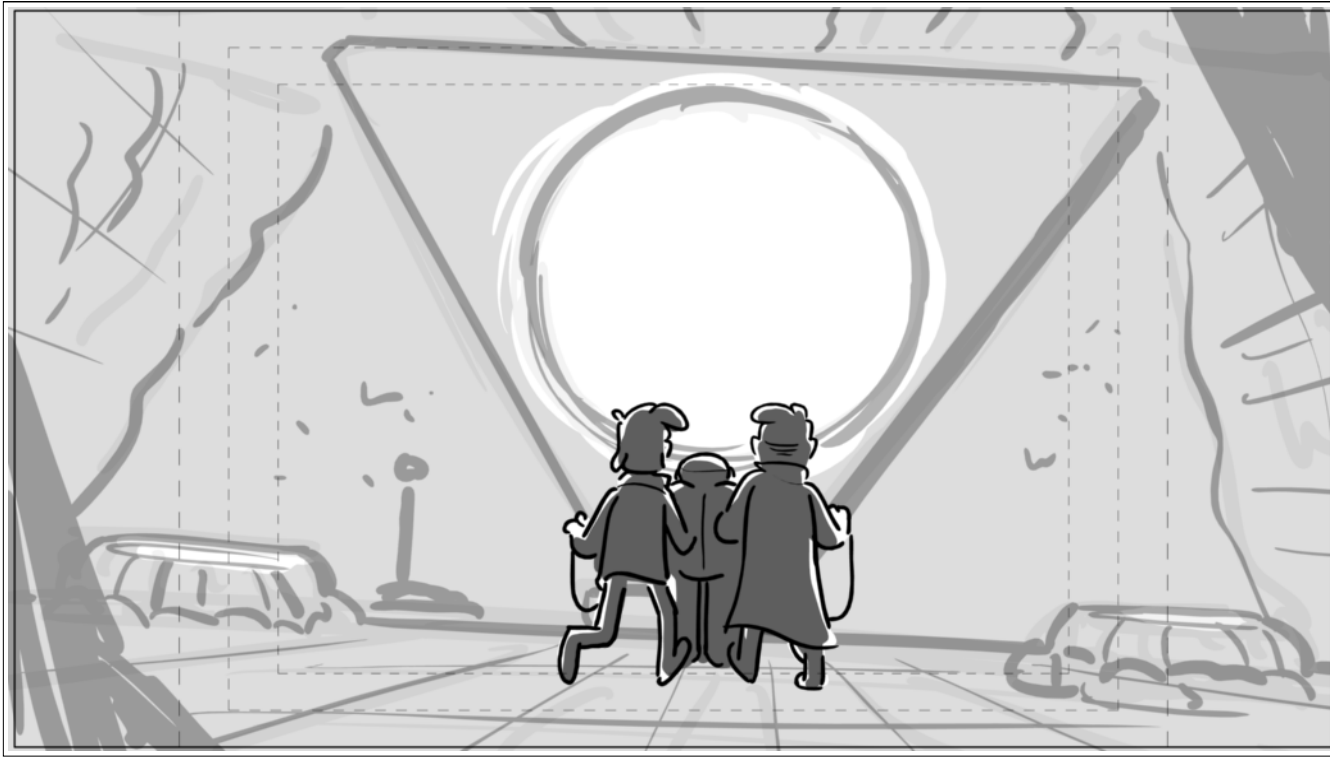

Action Notes

Dialog

The time had come to test it.

Scene 016\_I\_2

Panel 1

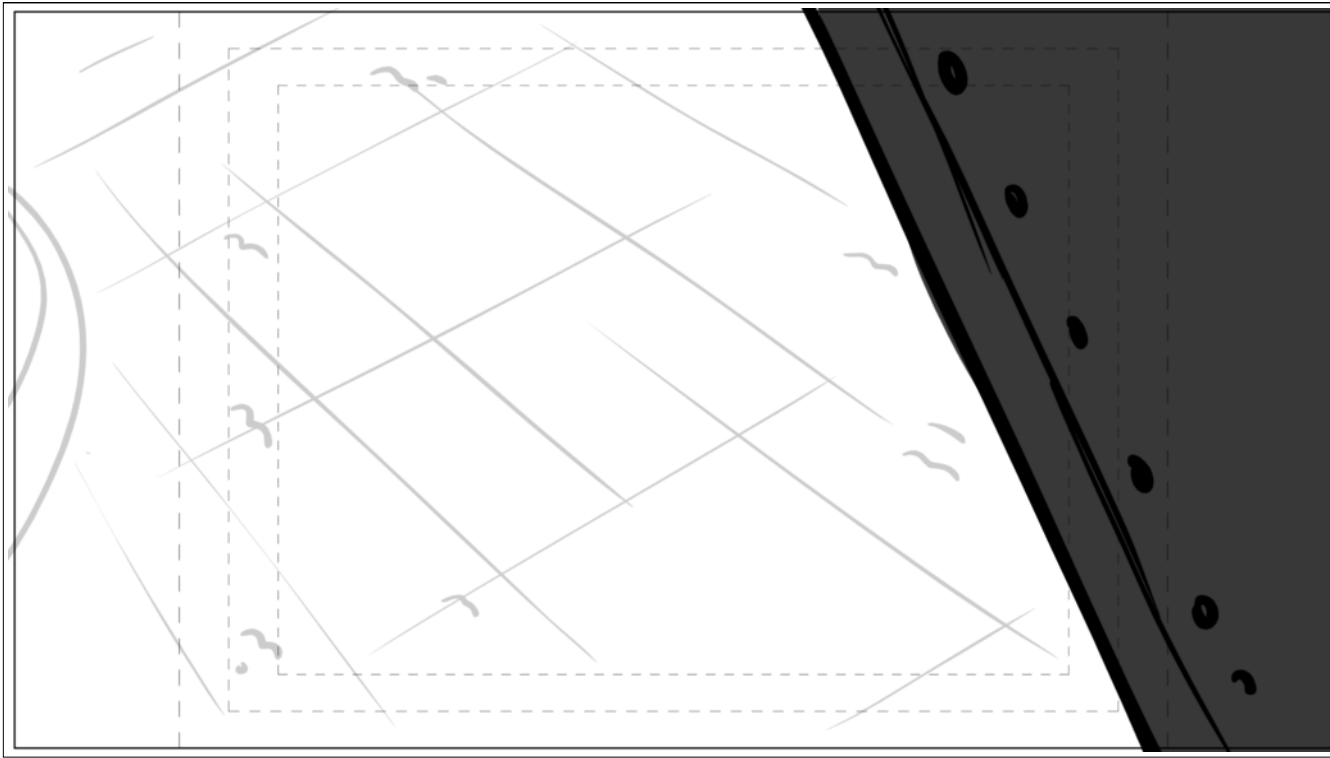

Action Notes

---

Dialog

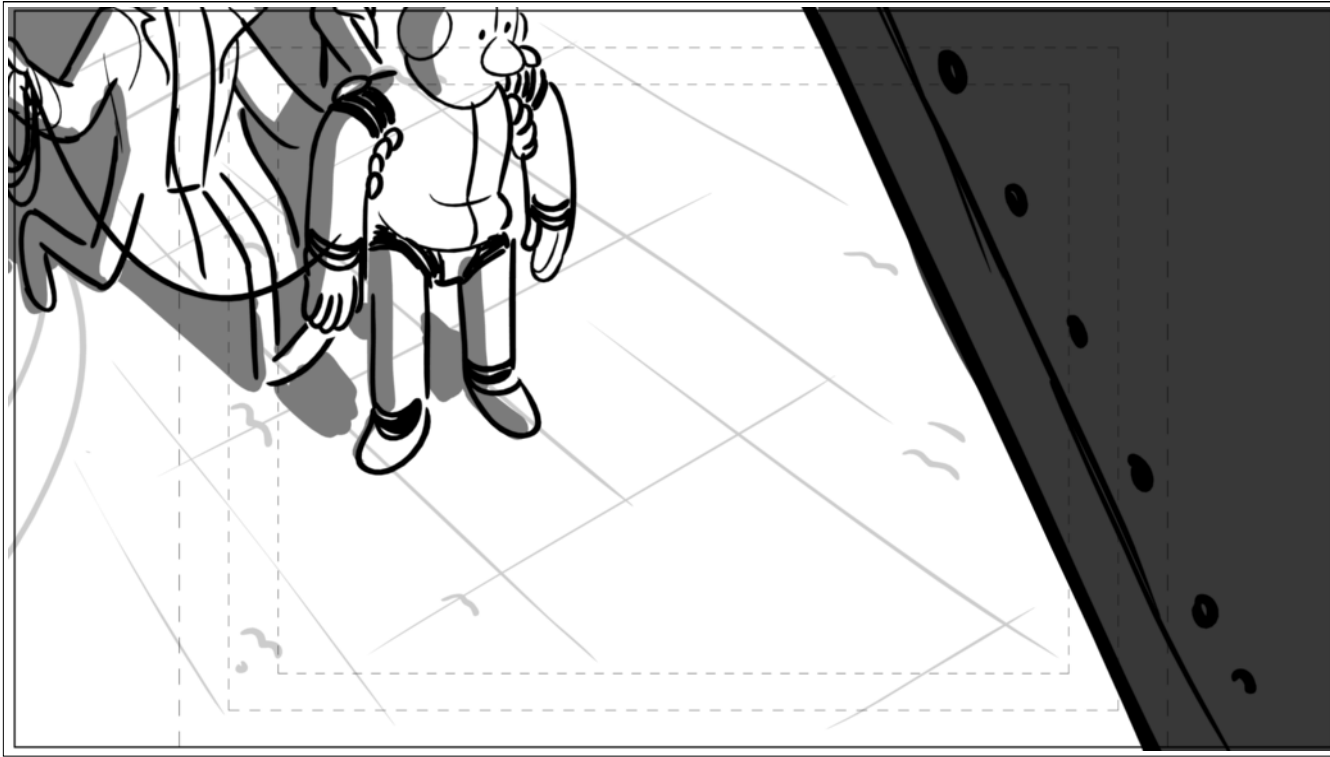

Action Notes

Dialog

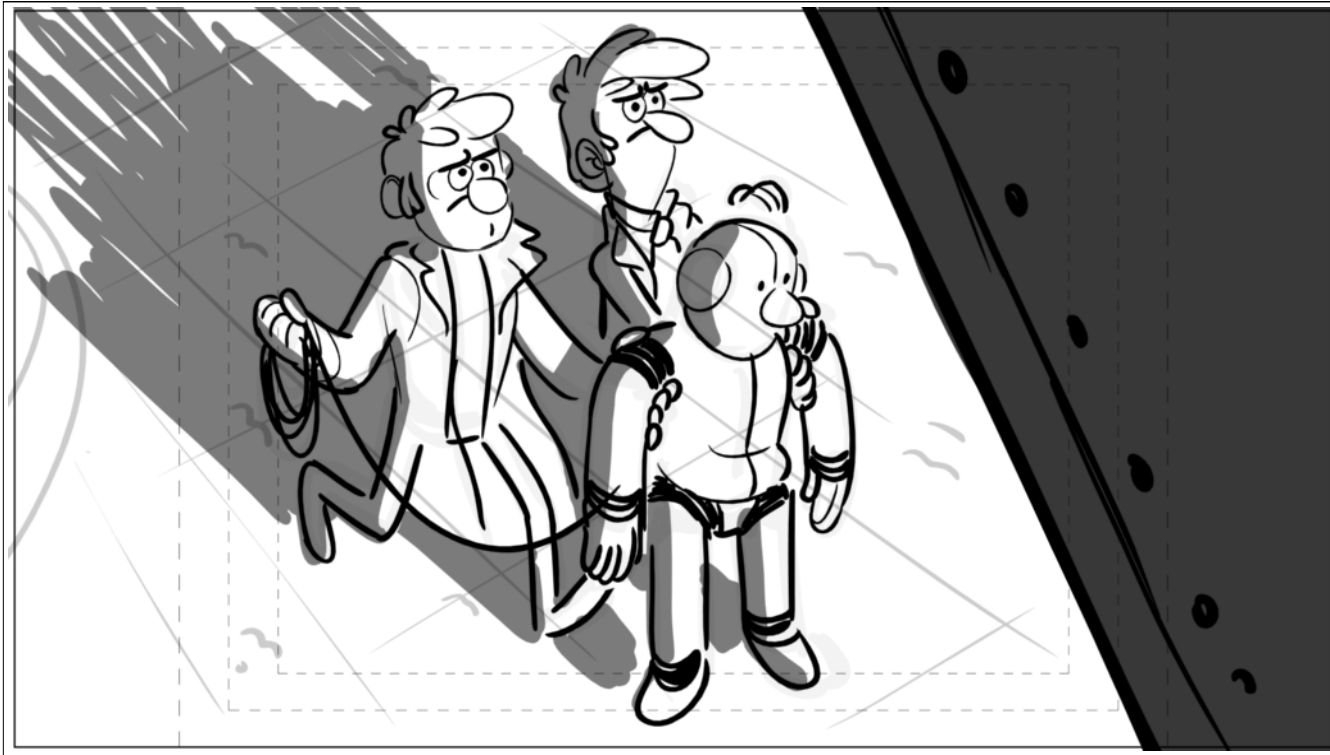

Action Notes

Dialog

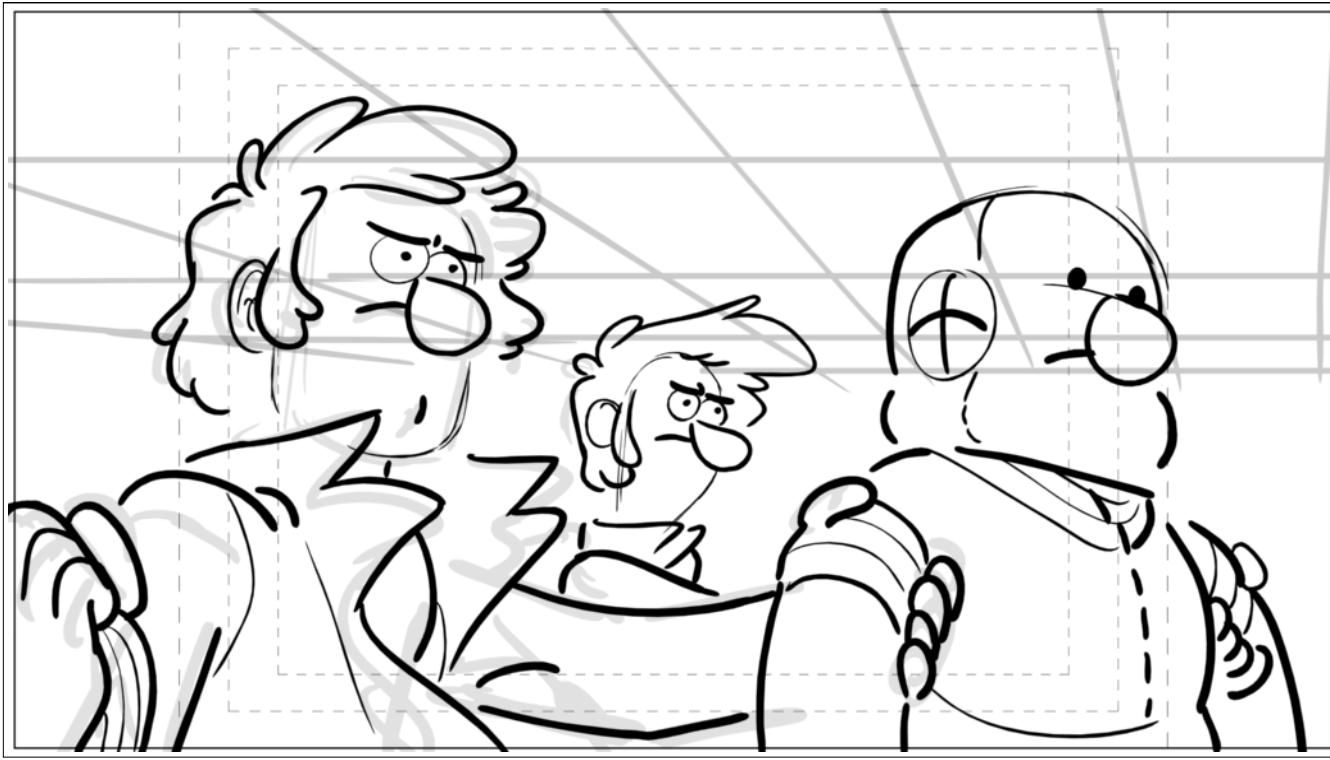

Action Notes

Dialog

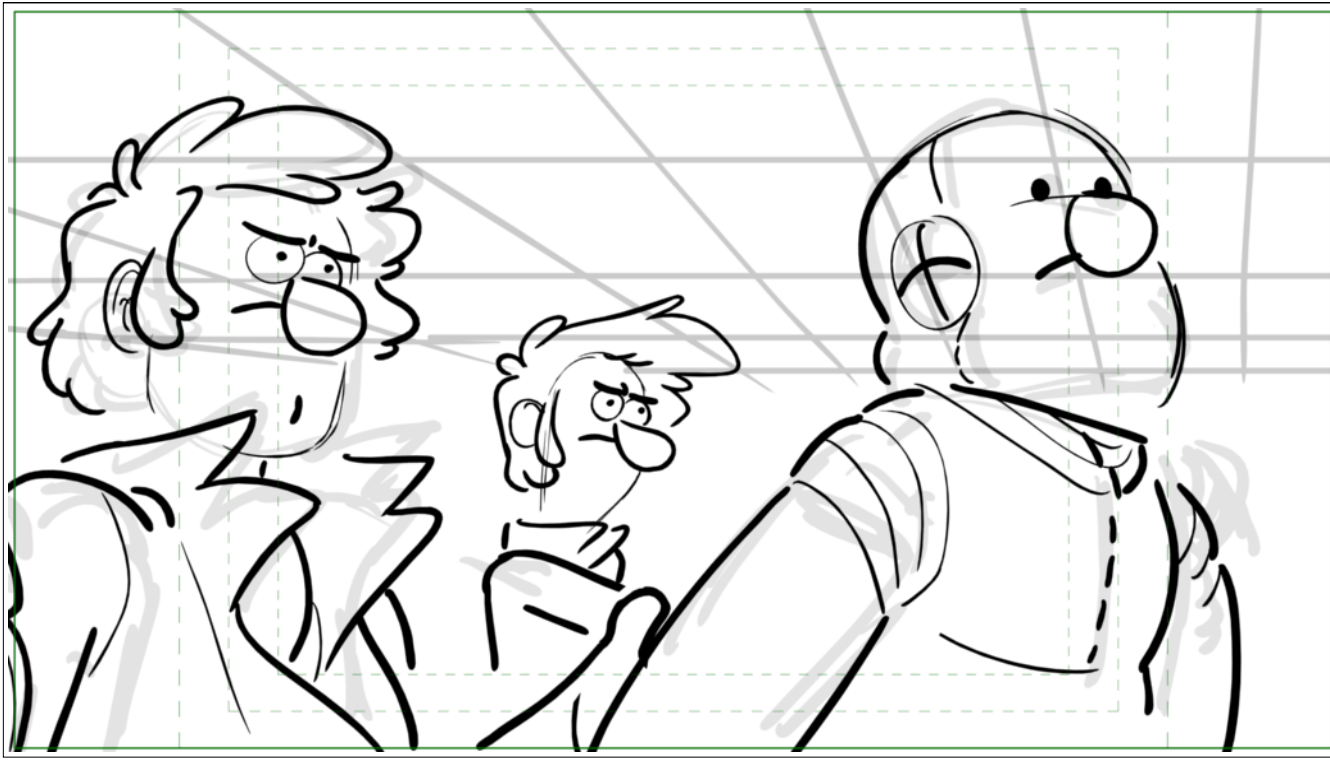

Action Notes

Dialog

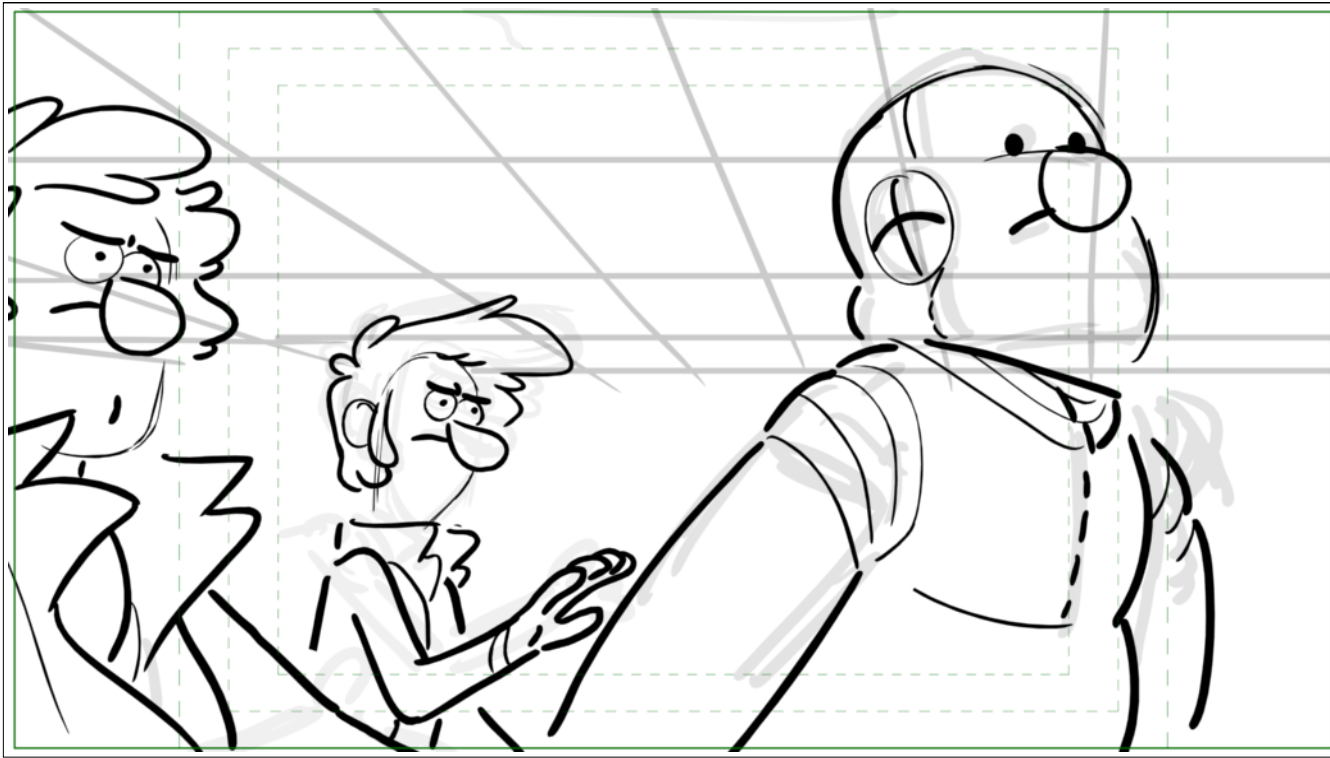

Action Notes

Dialog

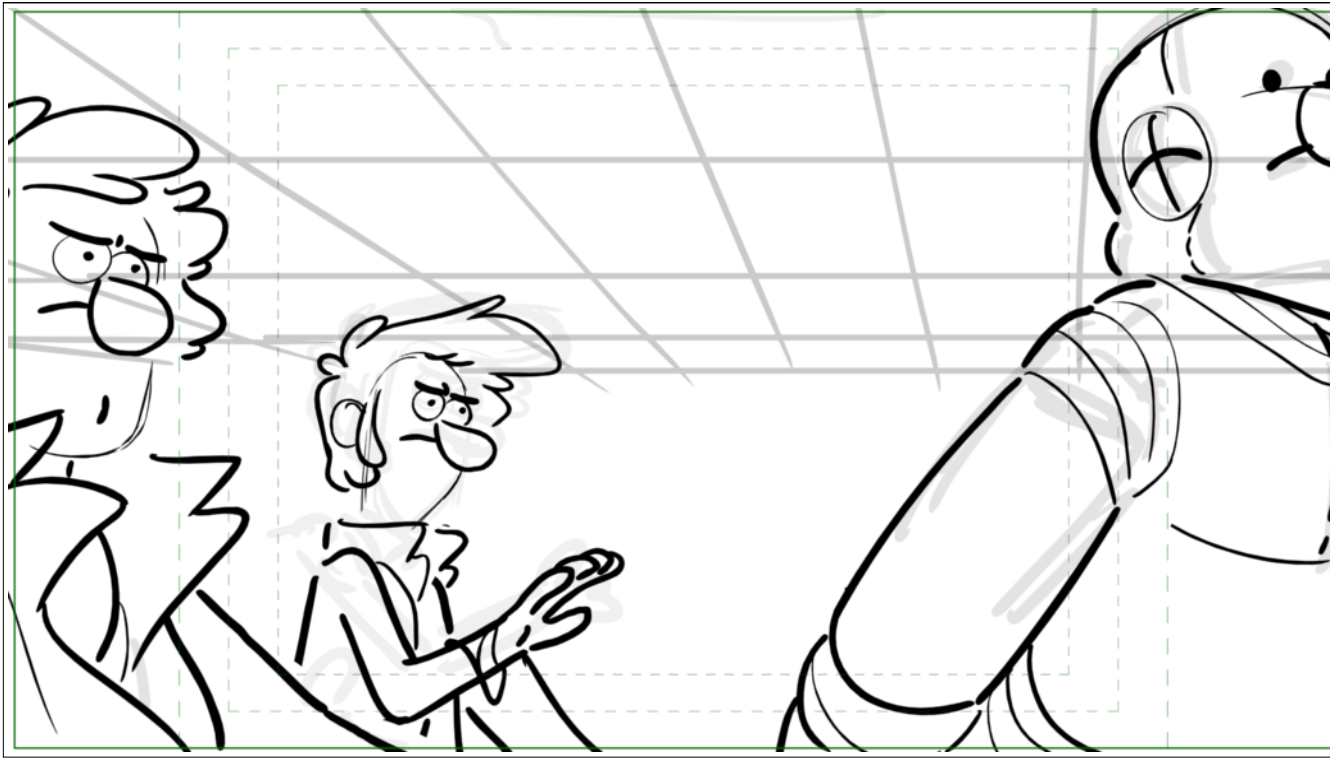

Action Notes

Dialog

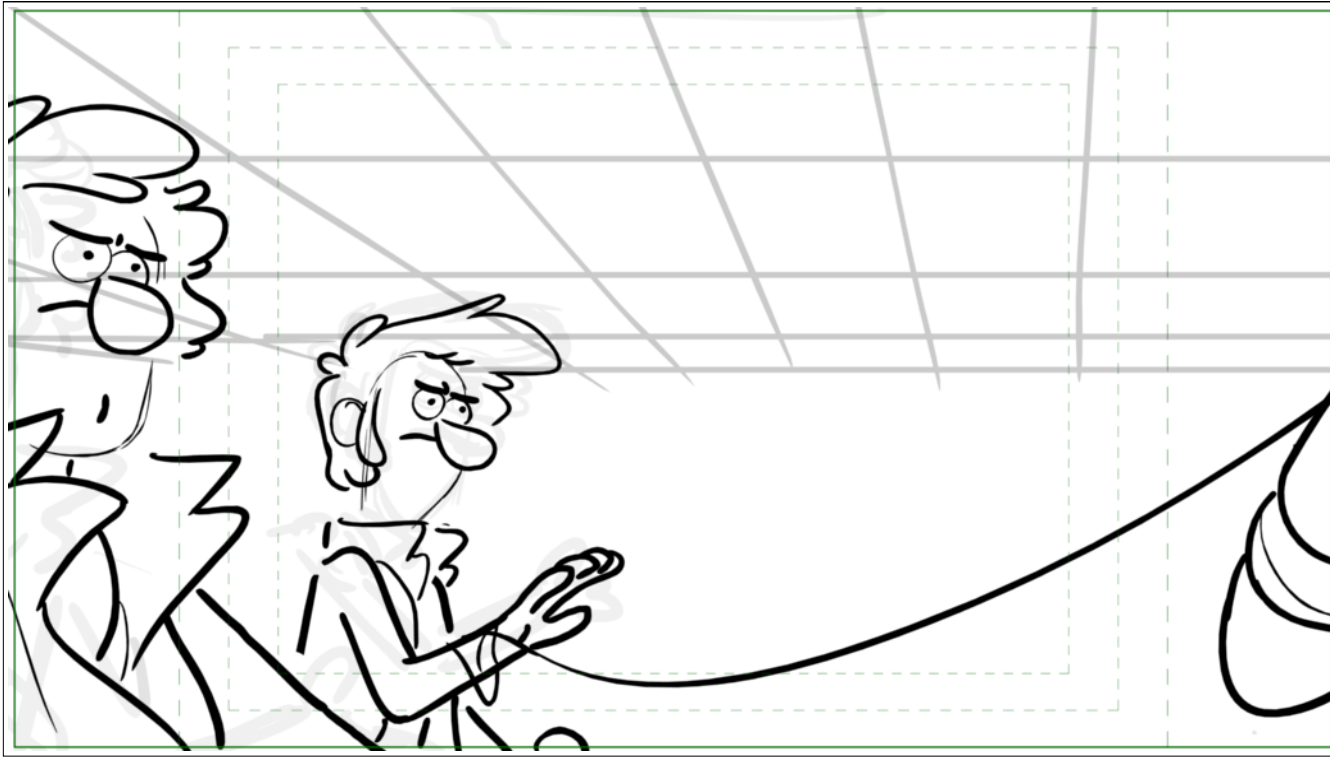

Action Notes

Dialog

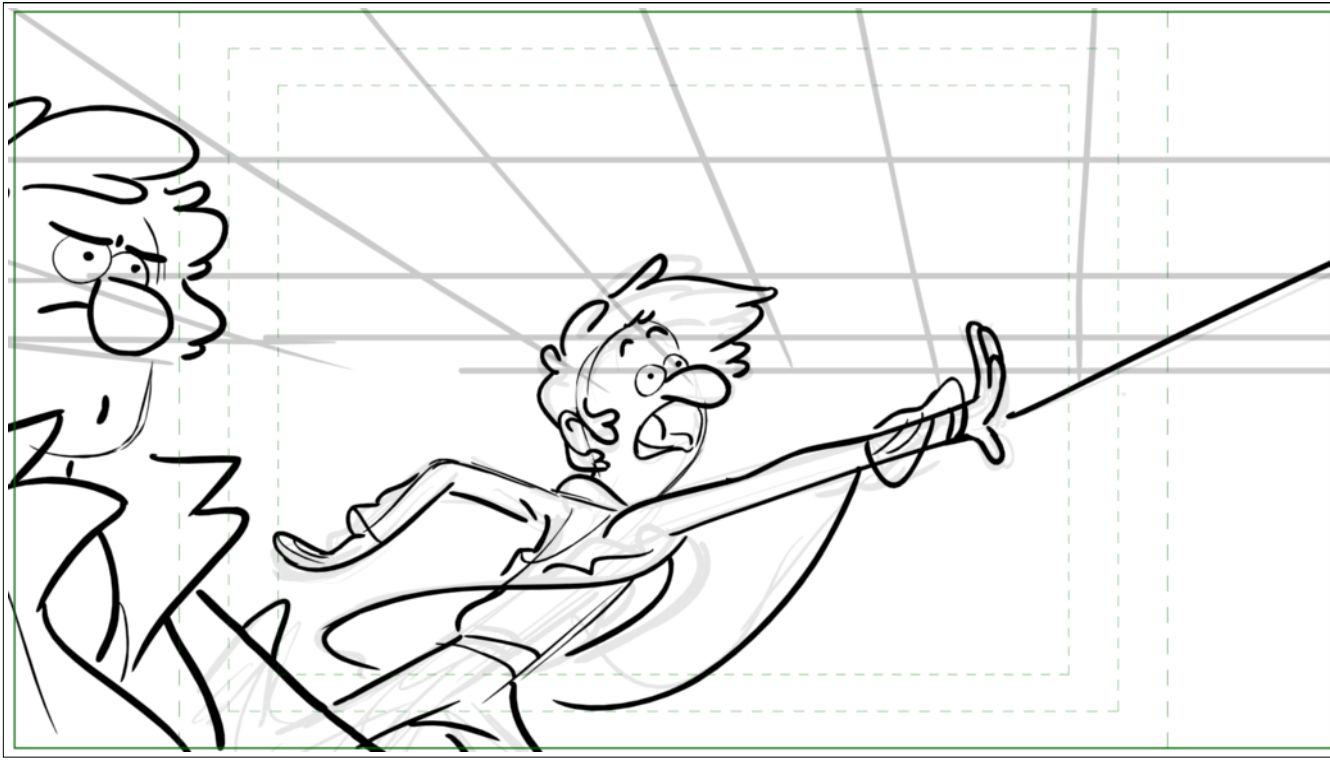

Action Notes

Dialog

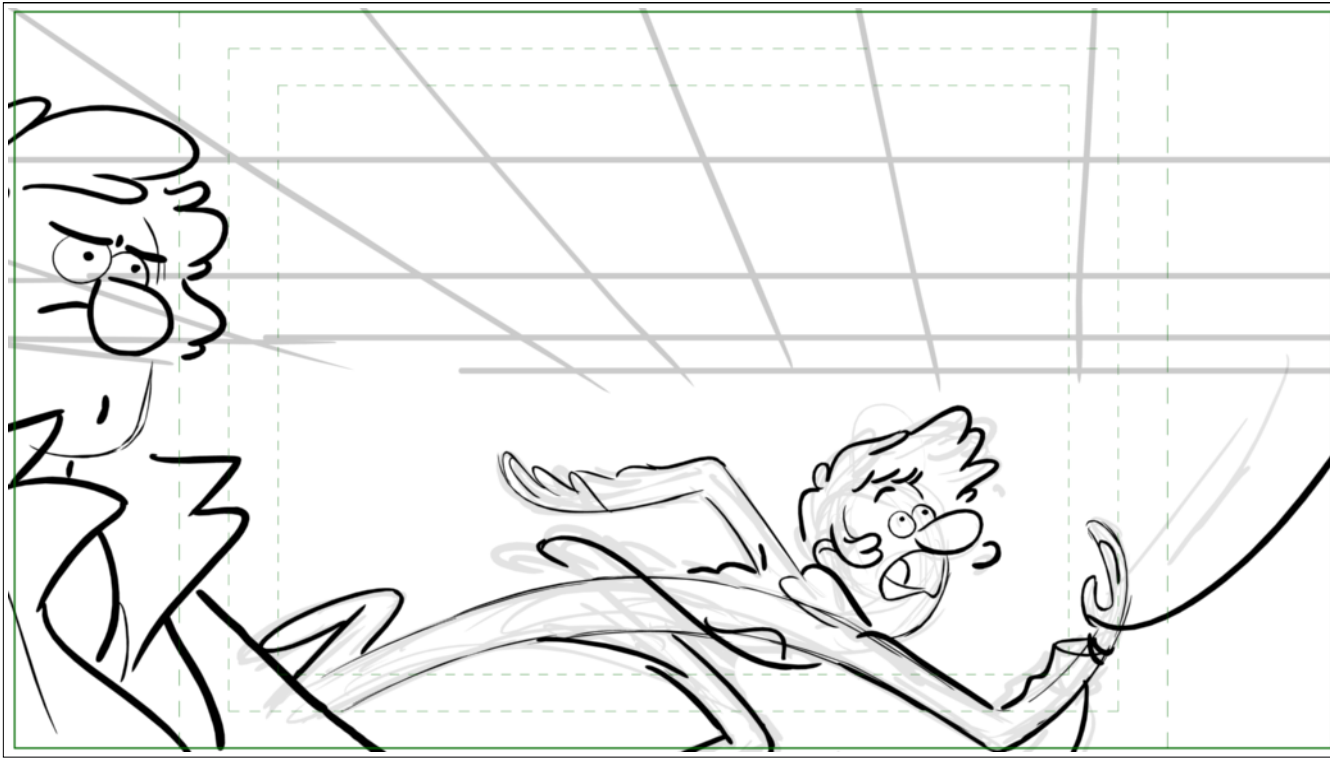

Action Notes

Dialog

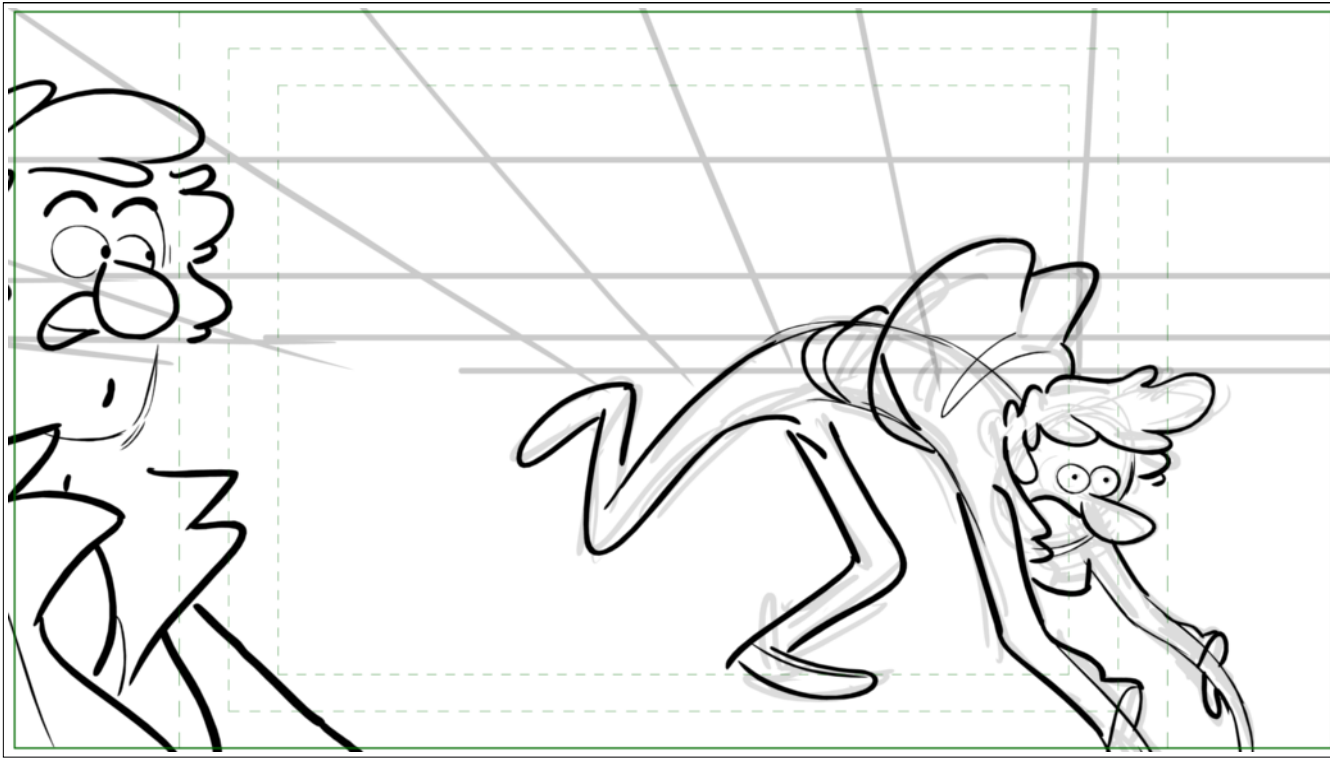

Action Notes

Dialog

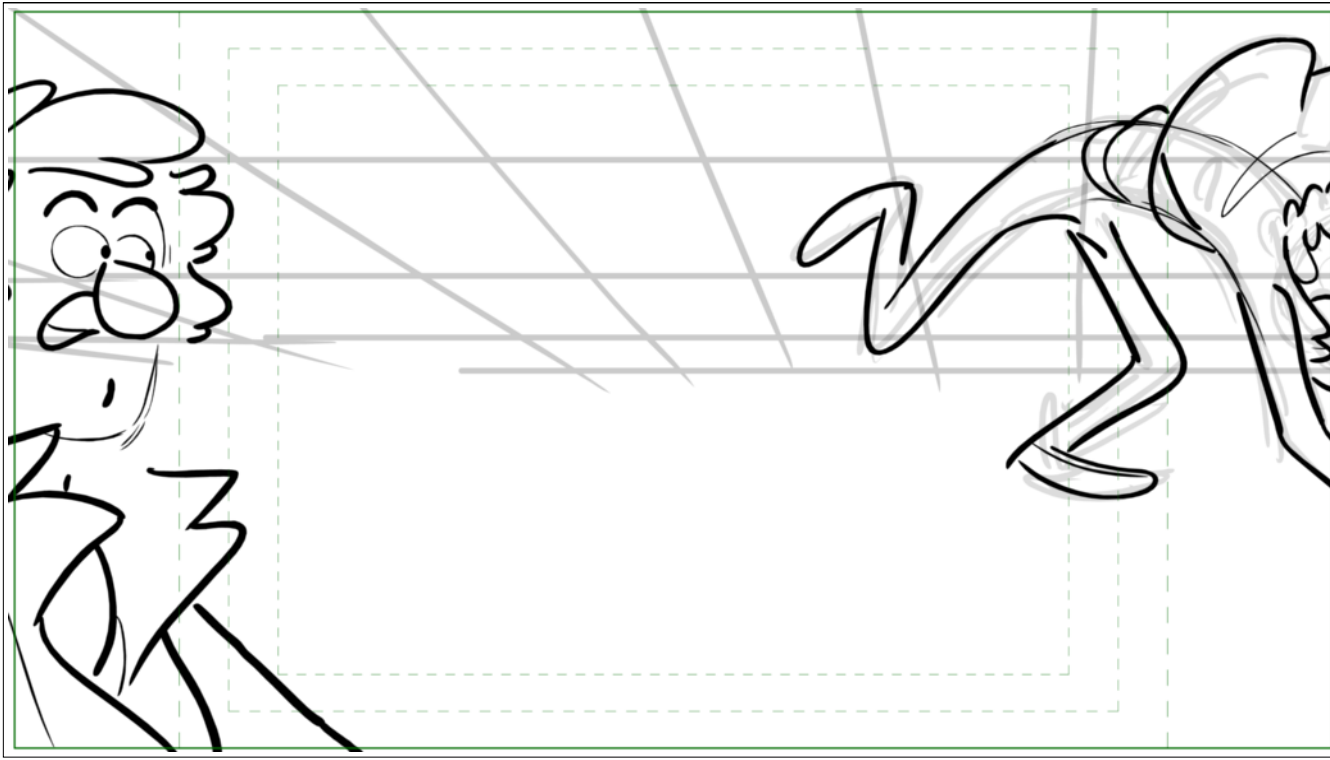

Action Notes

Dialog

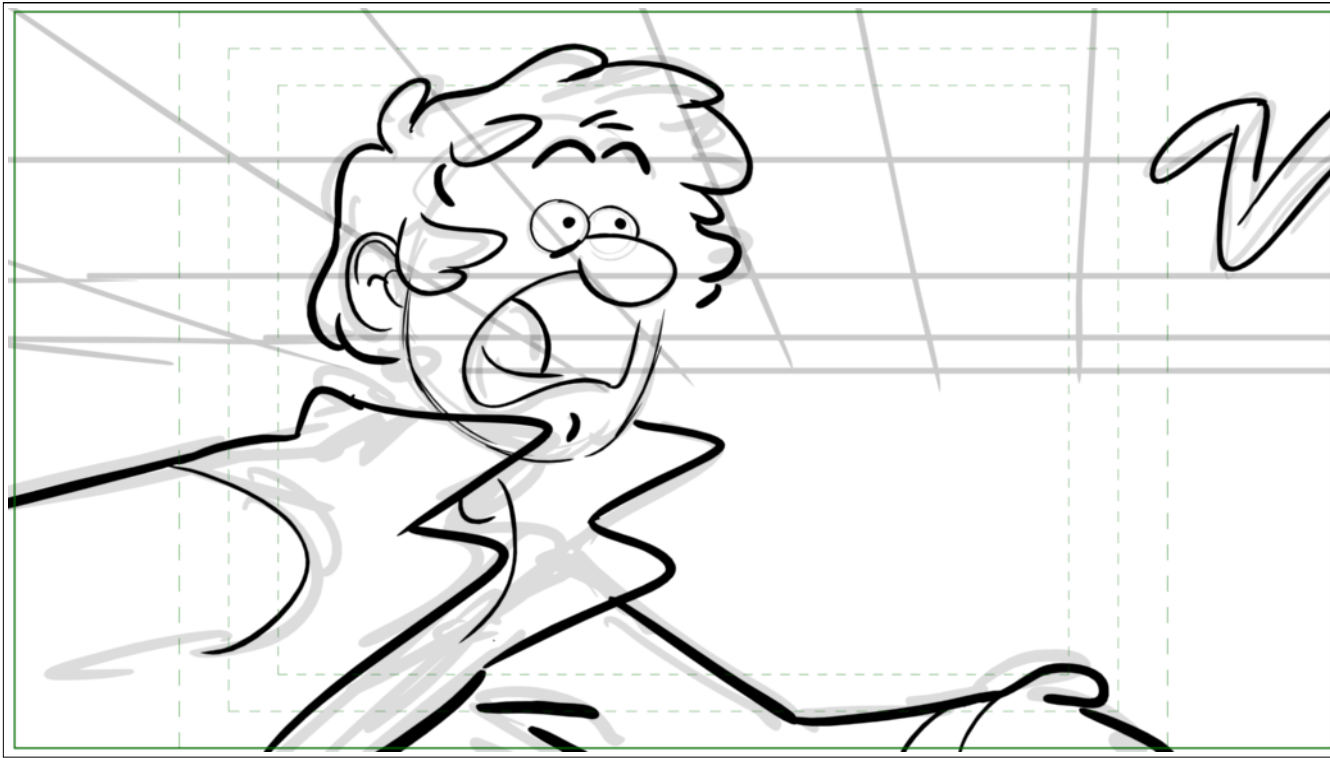

Action Notes

Dialog



Action Notes

---

Dialog



Action Notes

Dialog

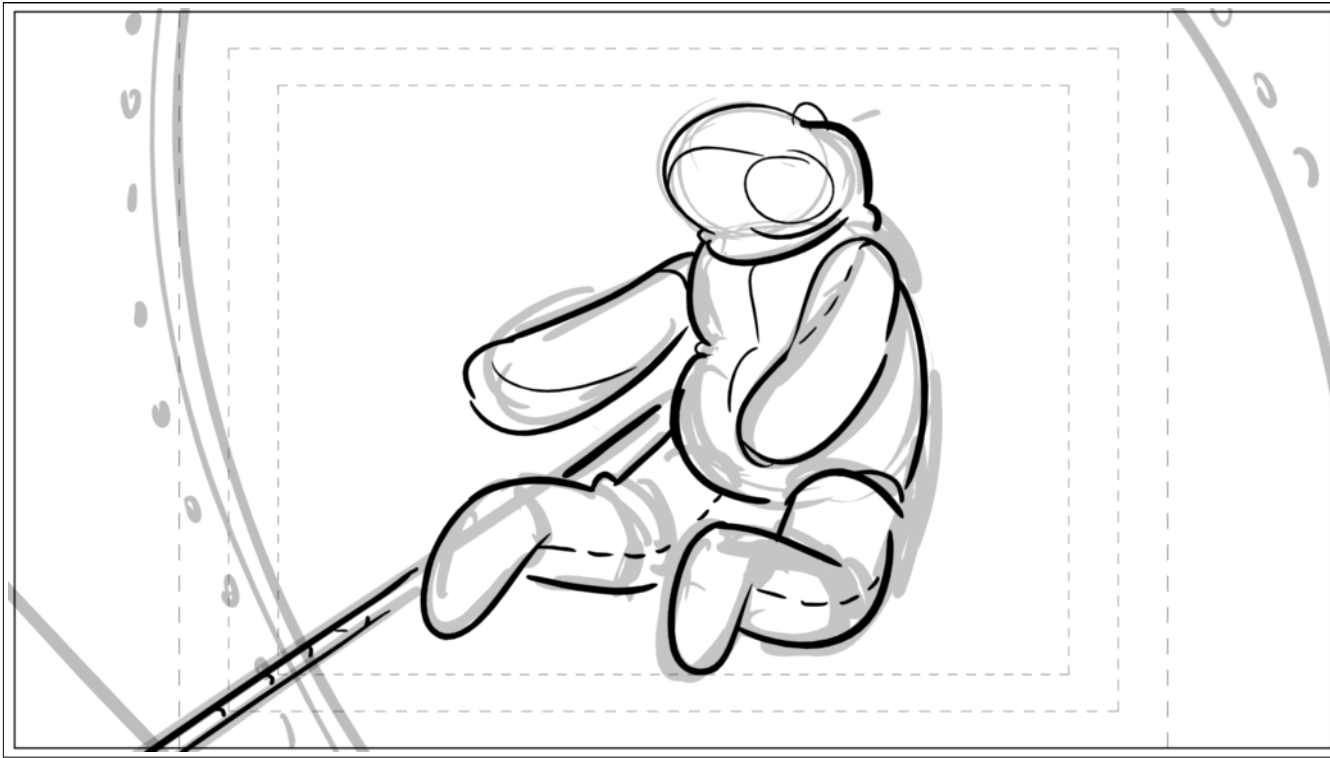

Action Notes

Dialog

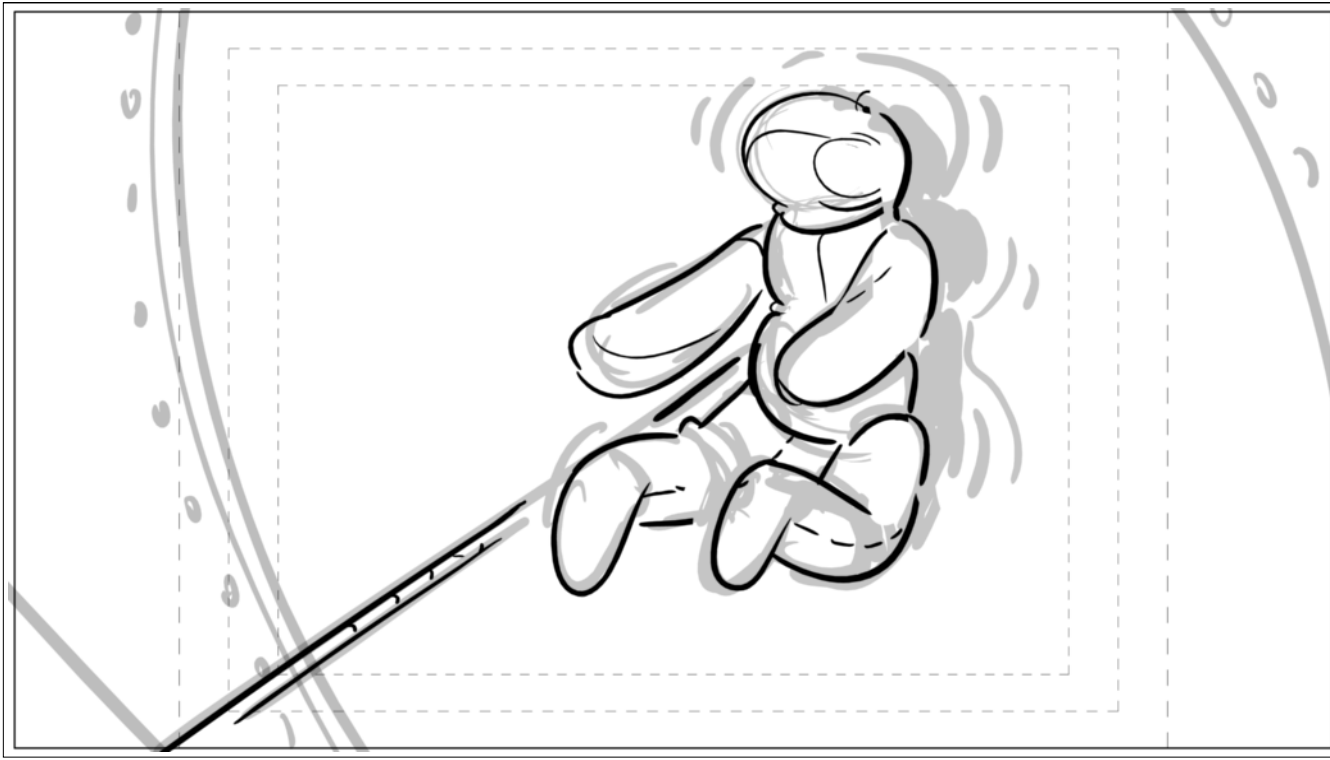

Action Notes

Dialog

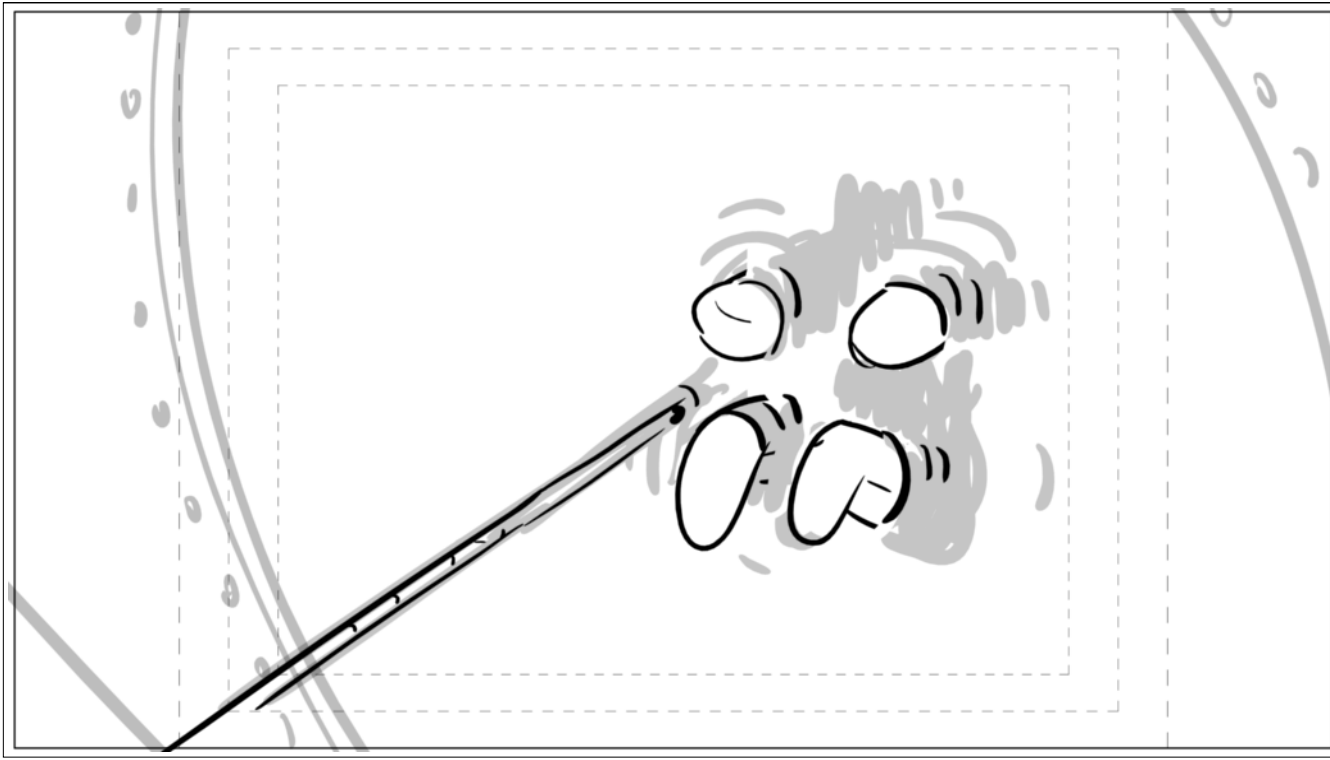

Action Notes

Dialog

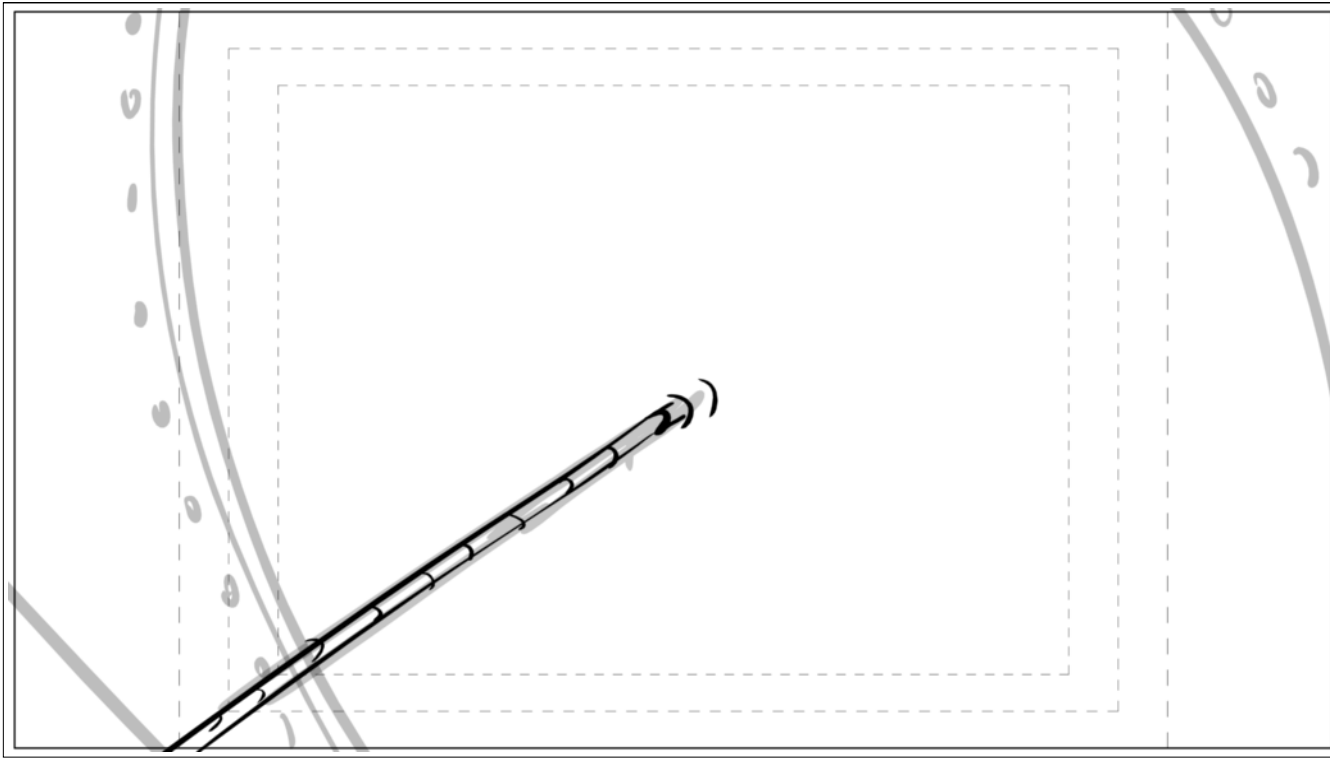

Action Notes

Dialog

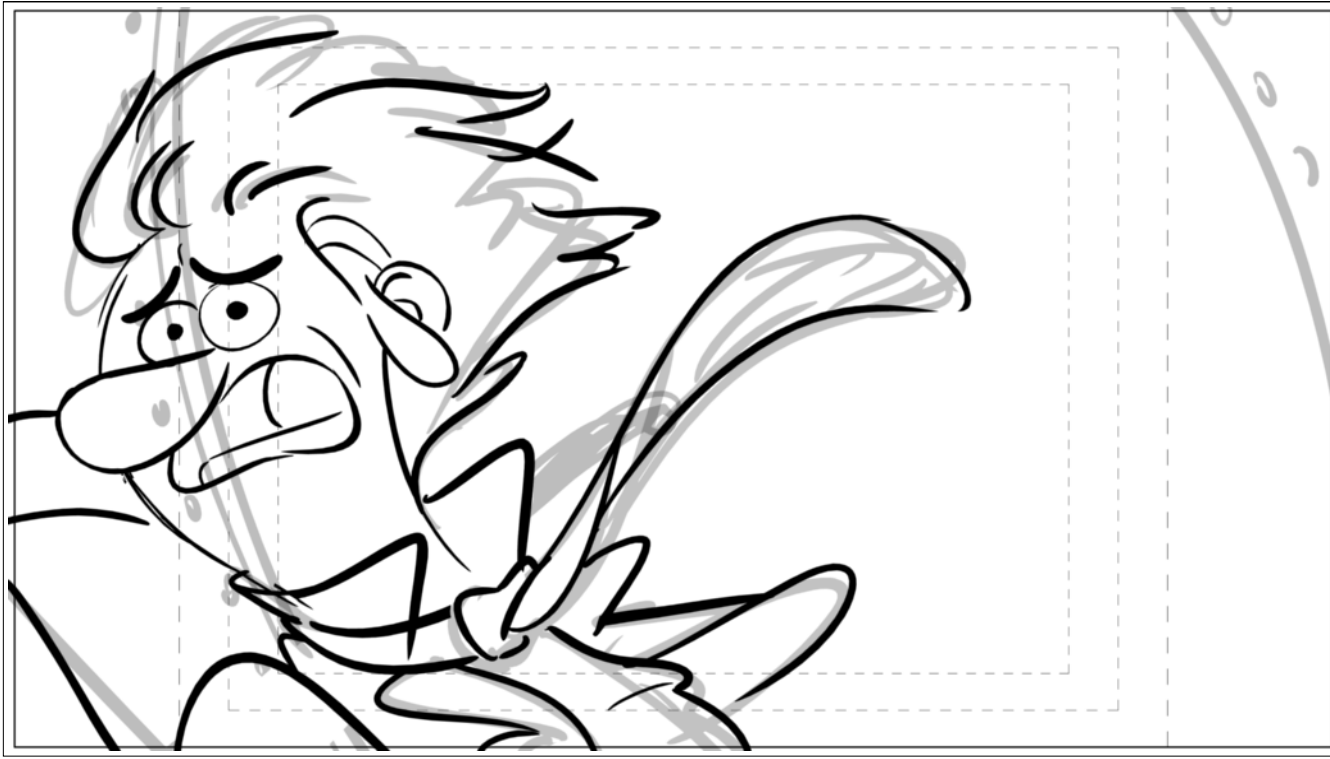

Action Notes

Dialog

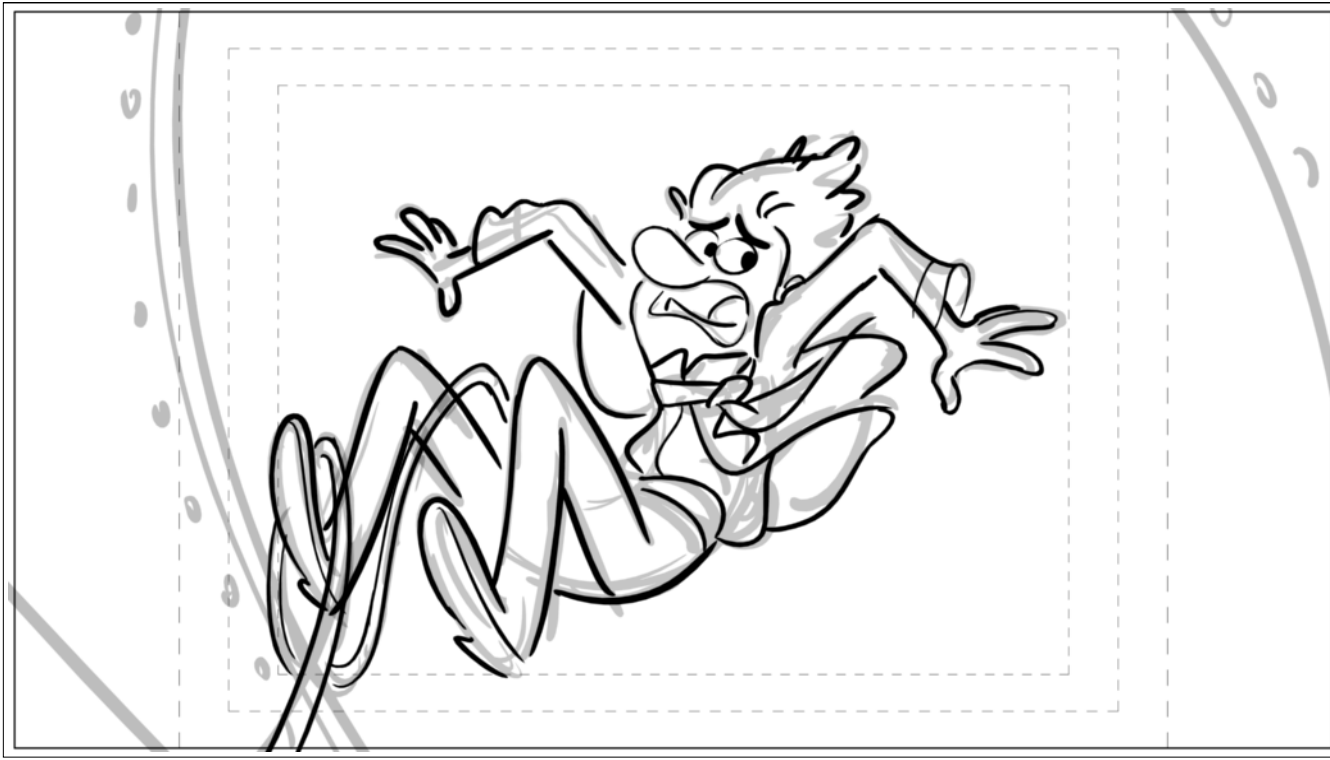

Action Notes

Dialog

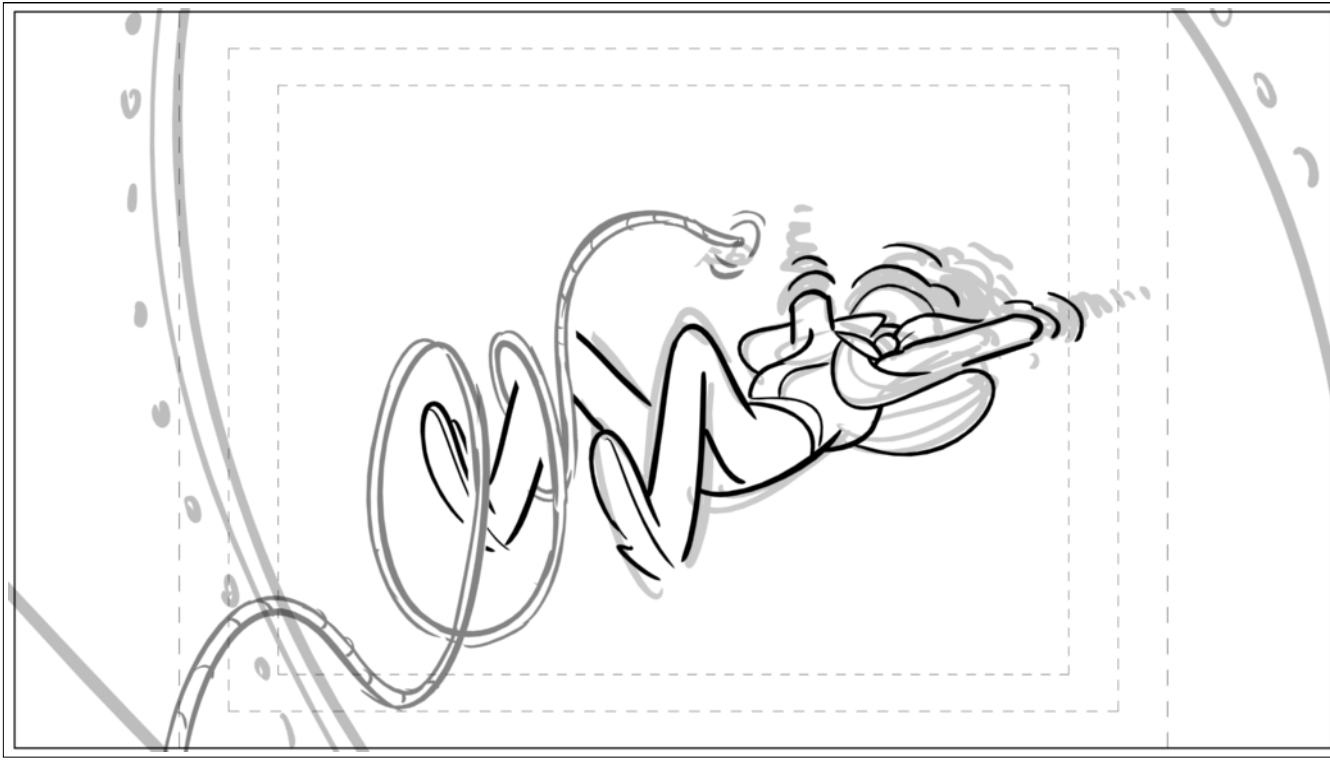

Action Notes

Dialog

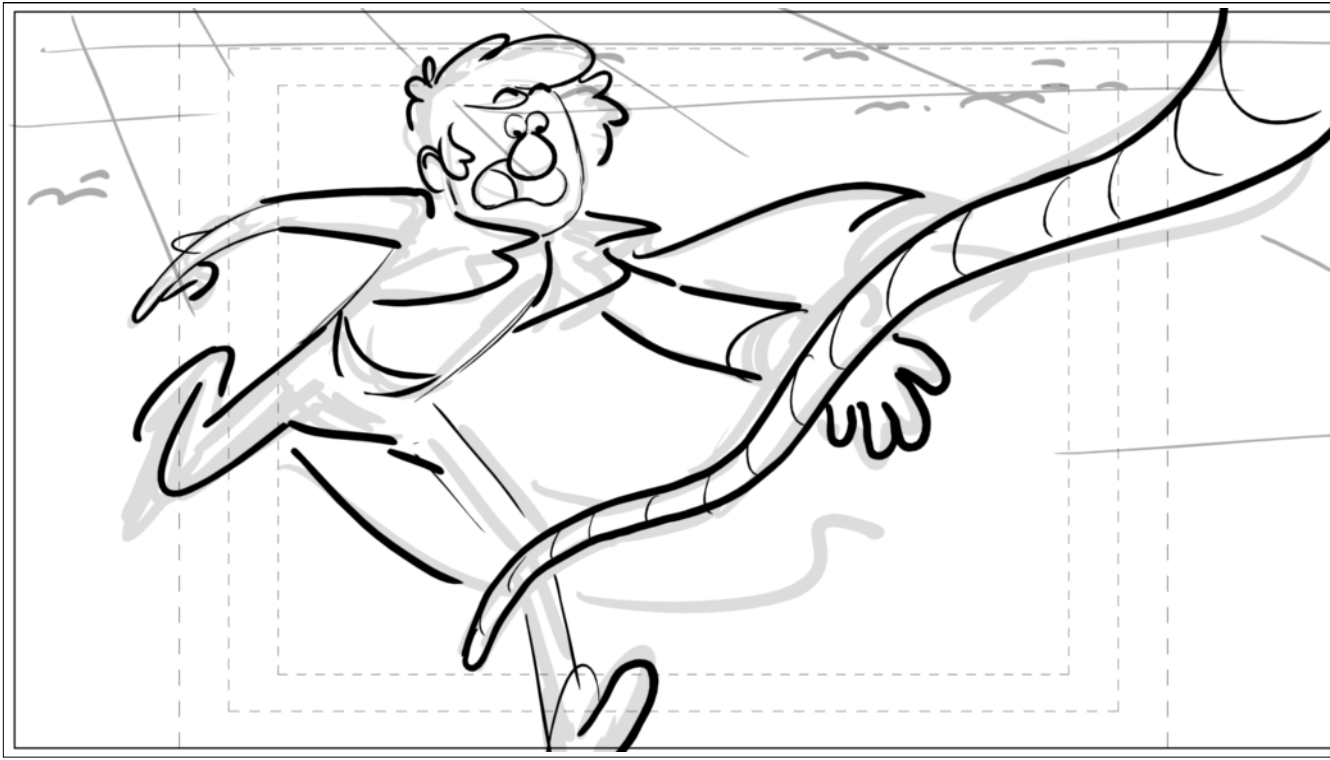

Action Notes

Dialog



Action Notes

Dialog

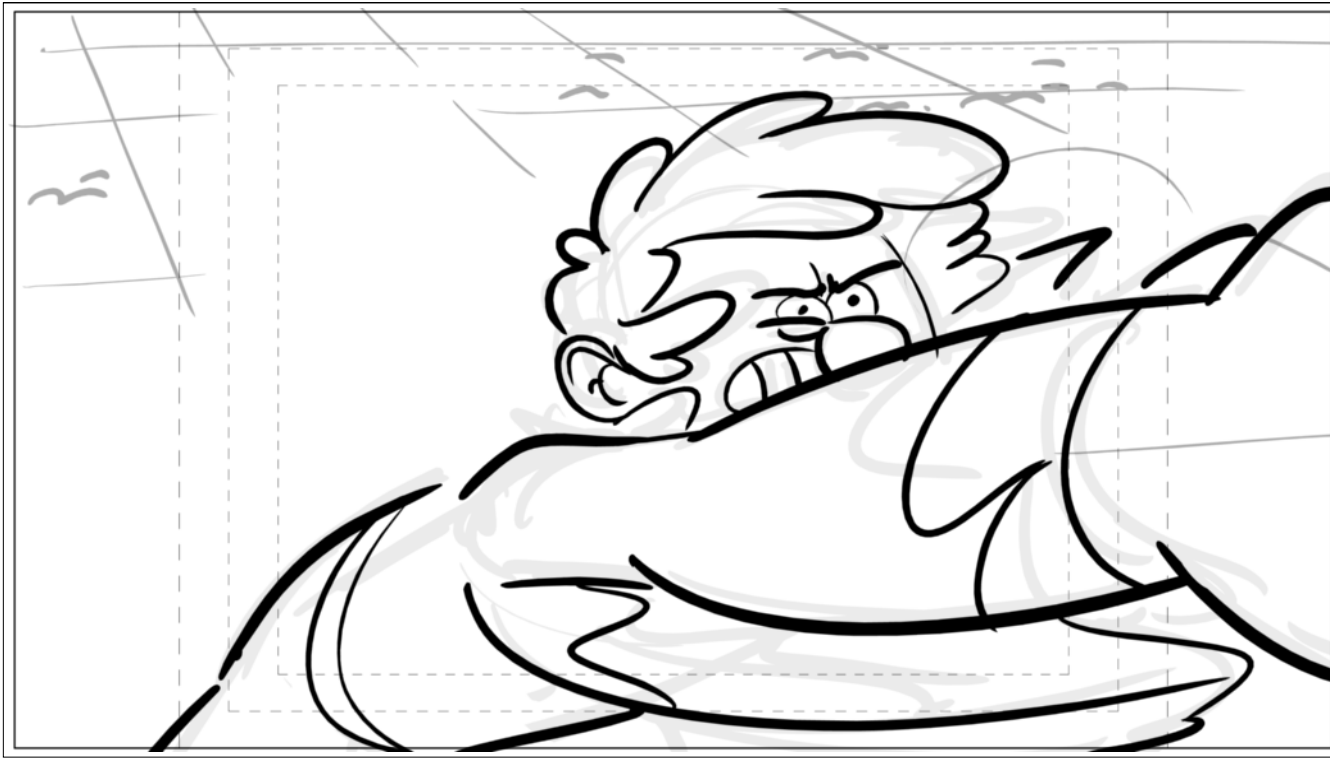

Action Notes

Dialog

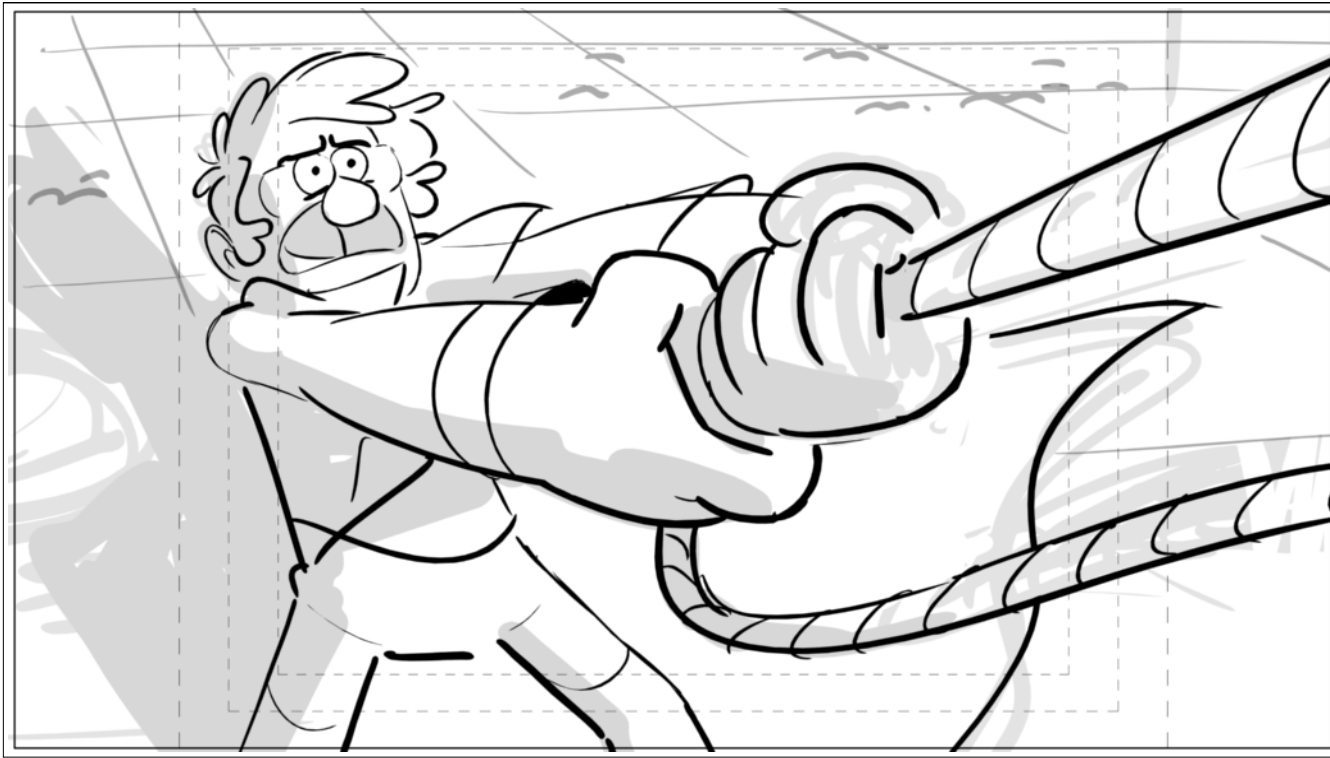

Action Notes

Dialog

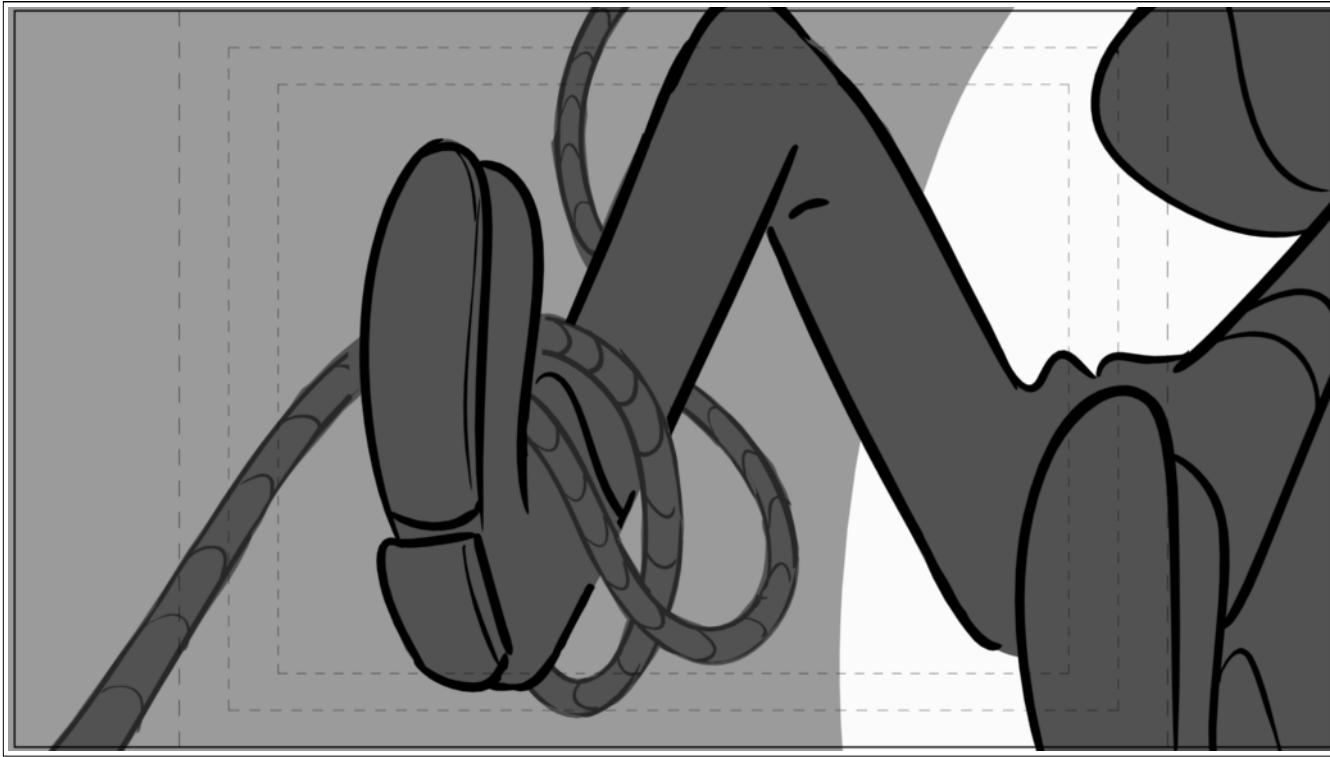

Action Notes

---

Dialog

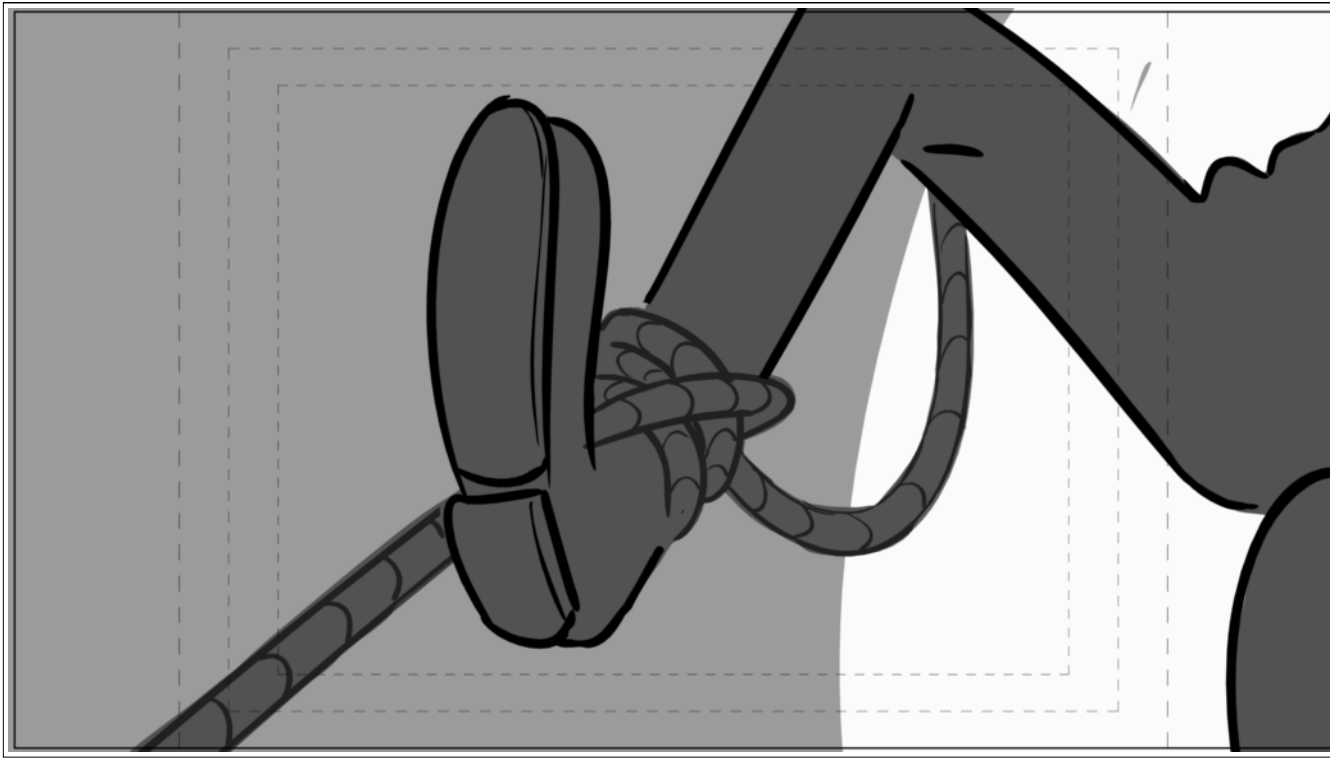

Action Notes

Dialog

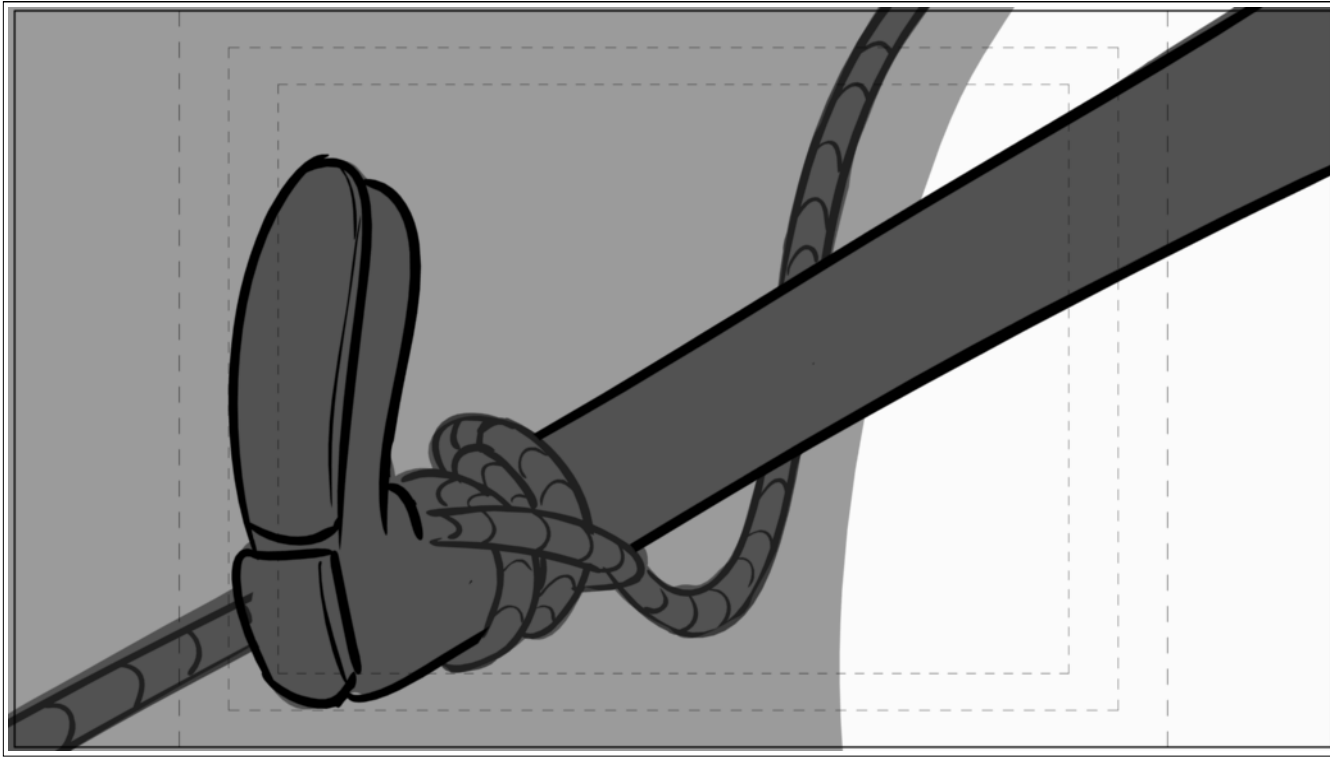

Action Notes

Dialog

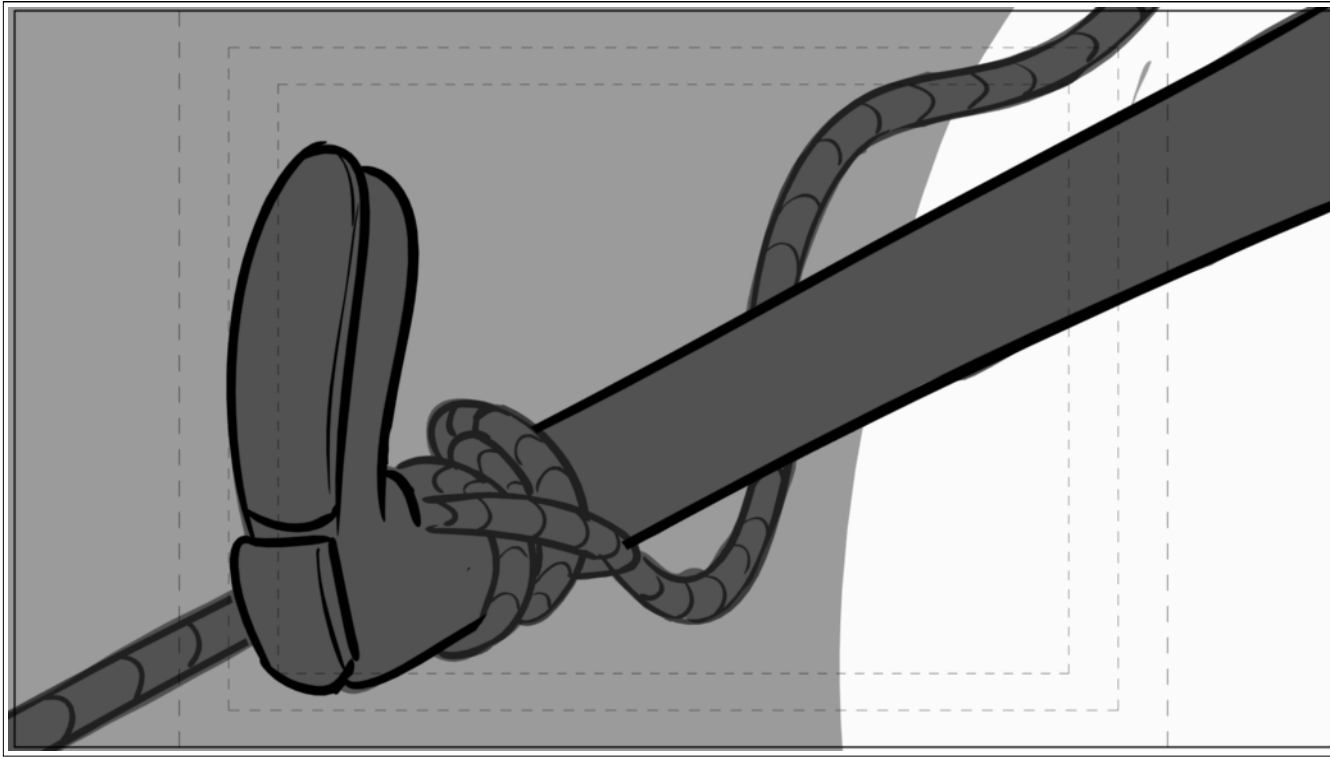

Action Notes

Dialog

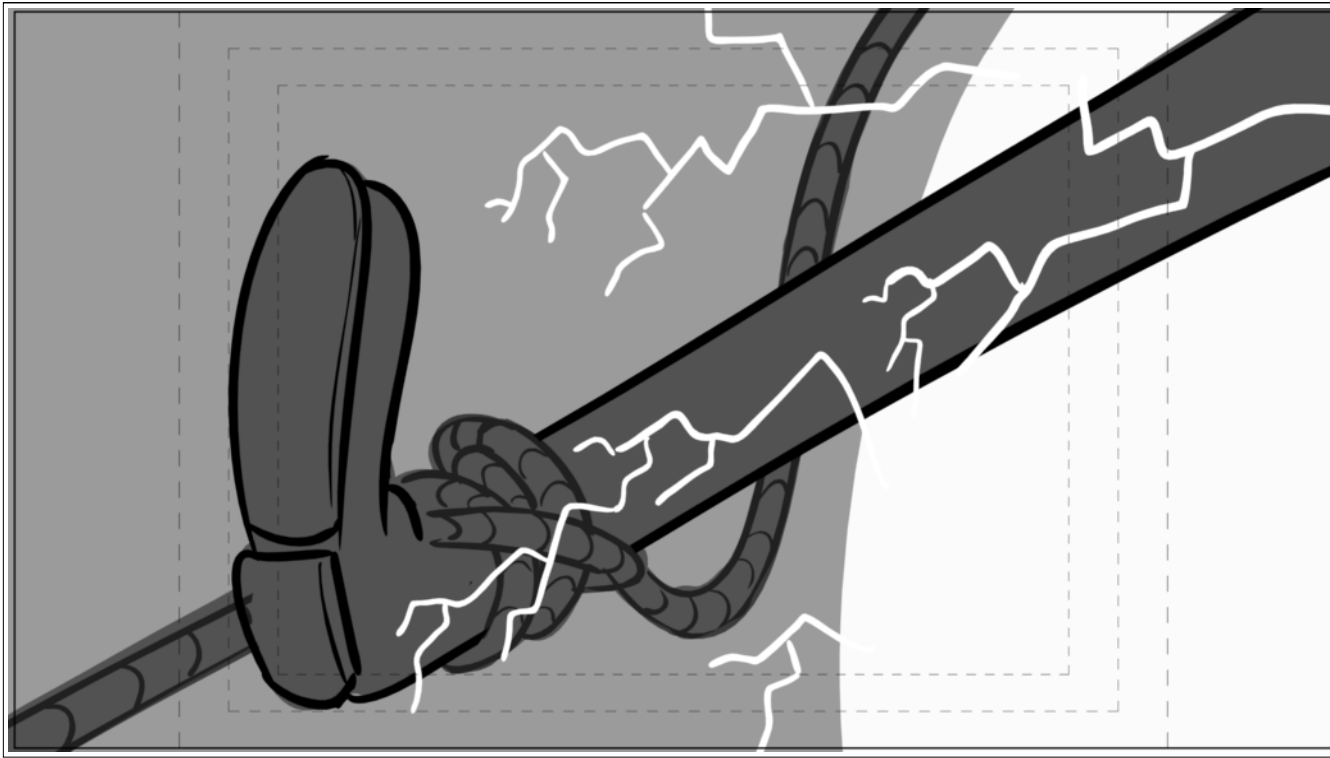

Action Notes

Dialog

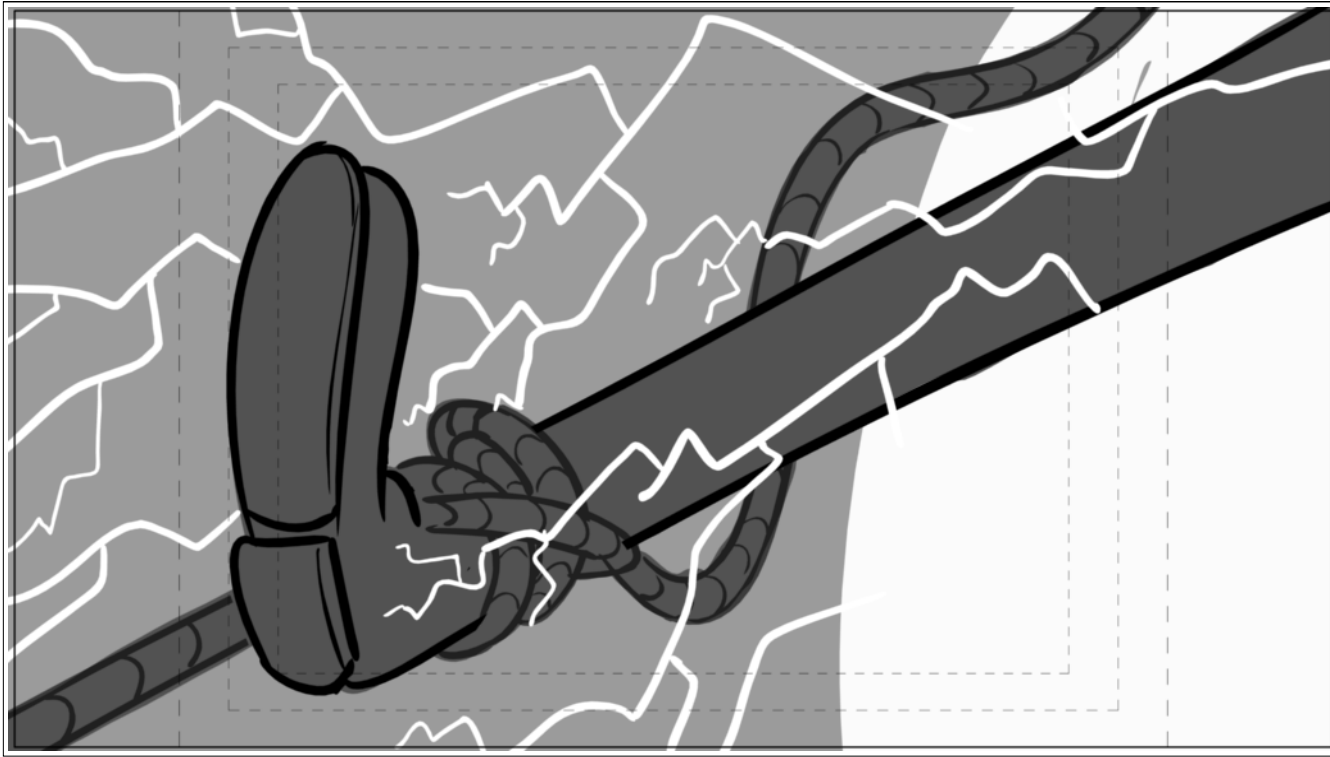

Action Notes

Dialog

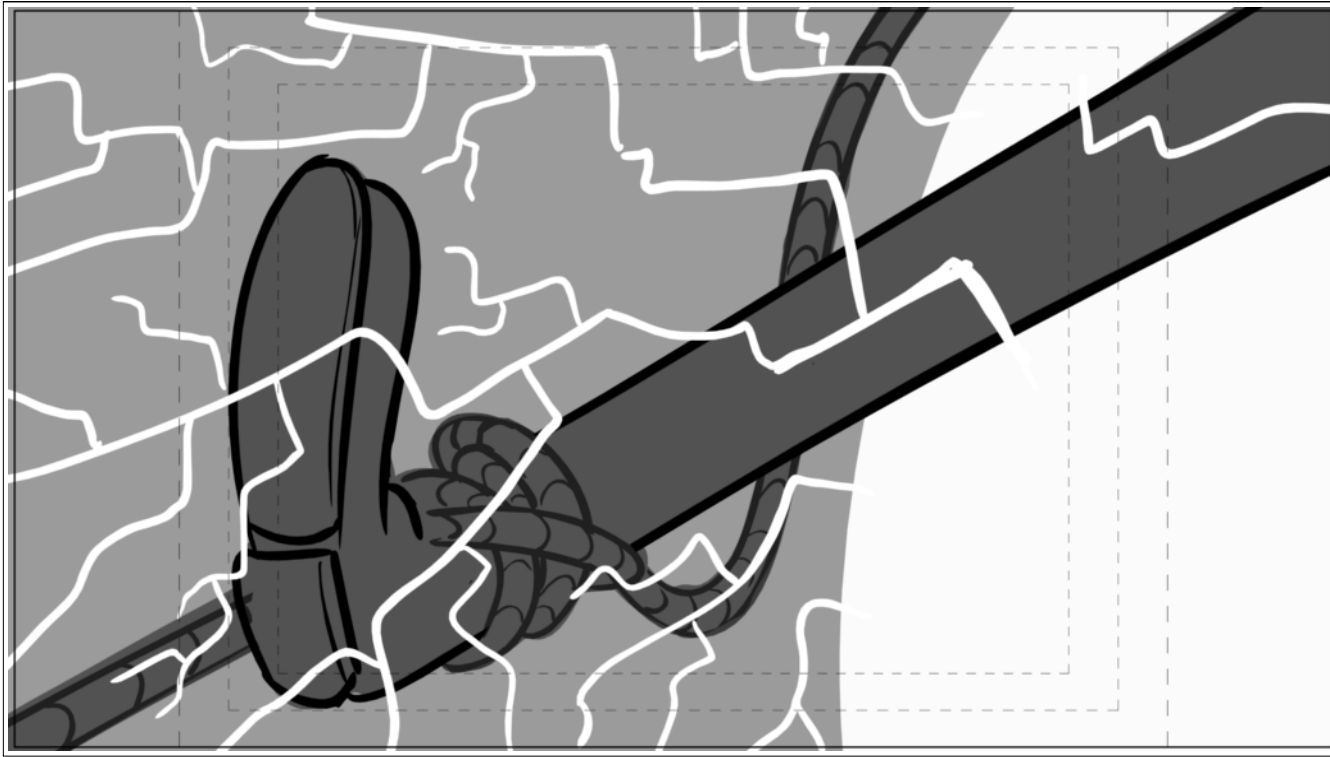

Action Notes

Dialog

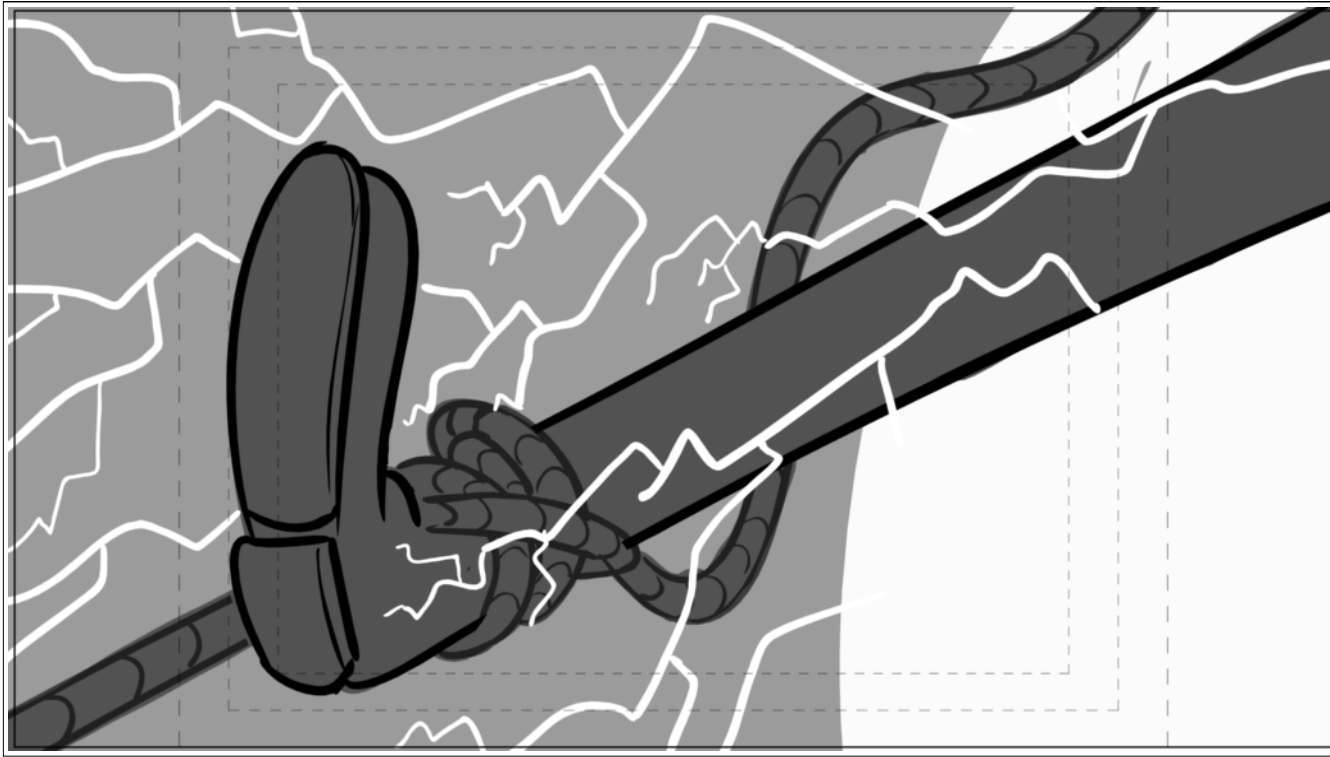

Action Notes

Dialog

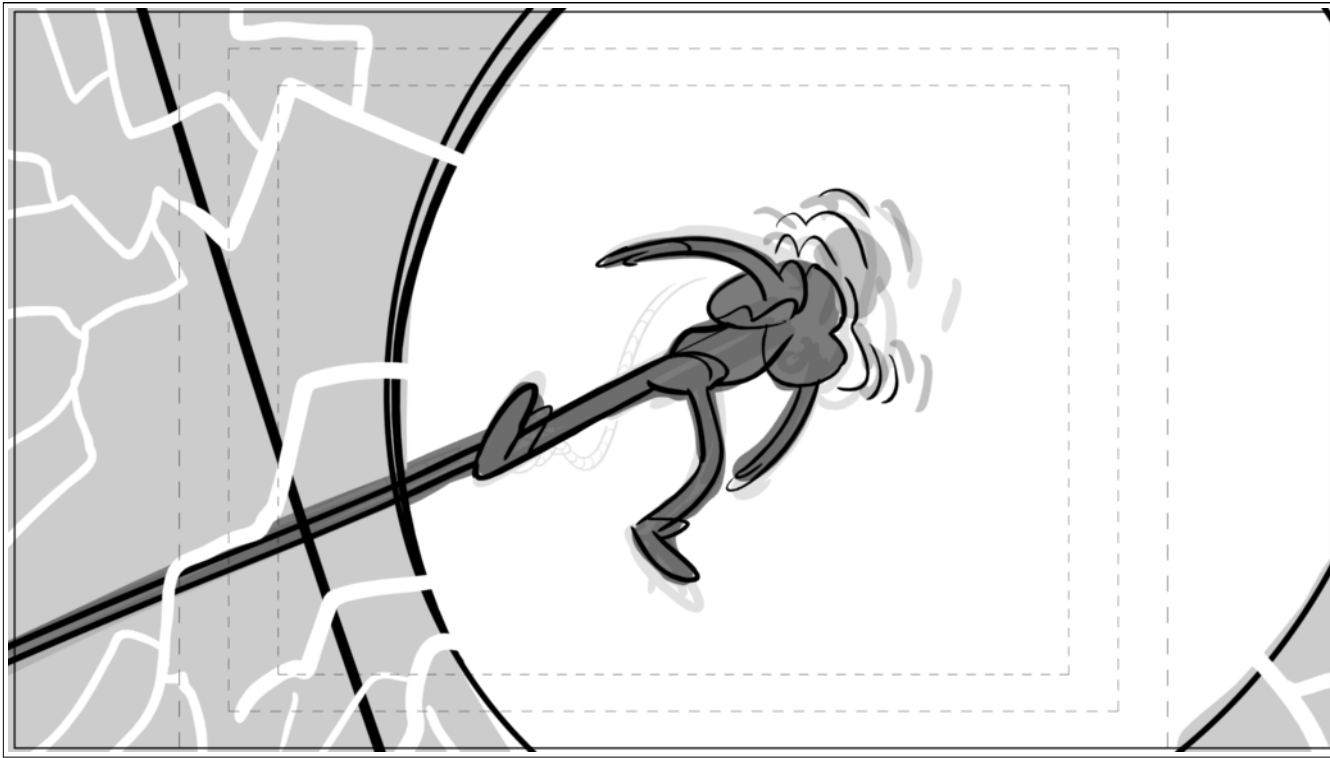

Action Notes

Dialog

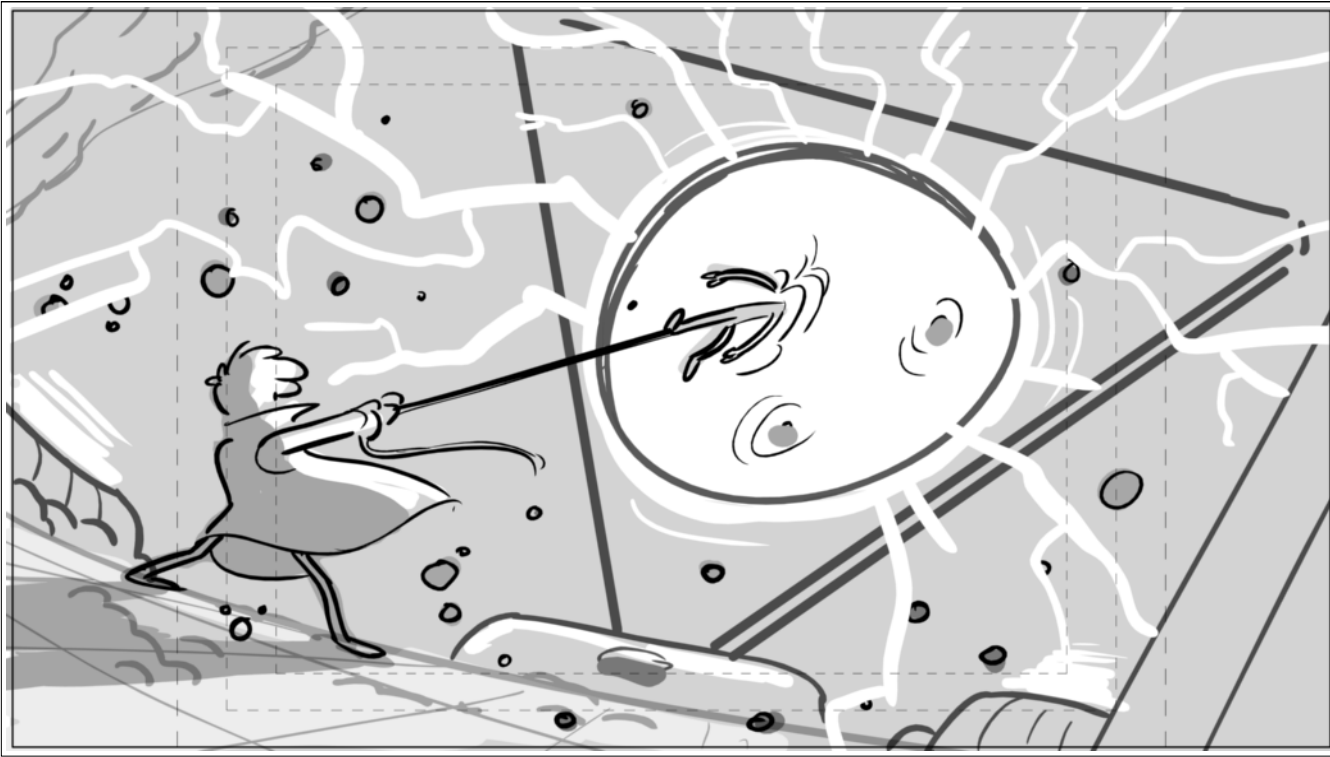

Action Notes

Dialog

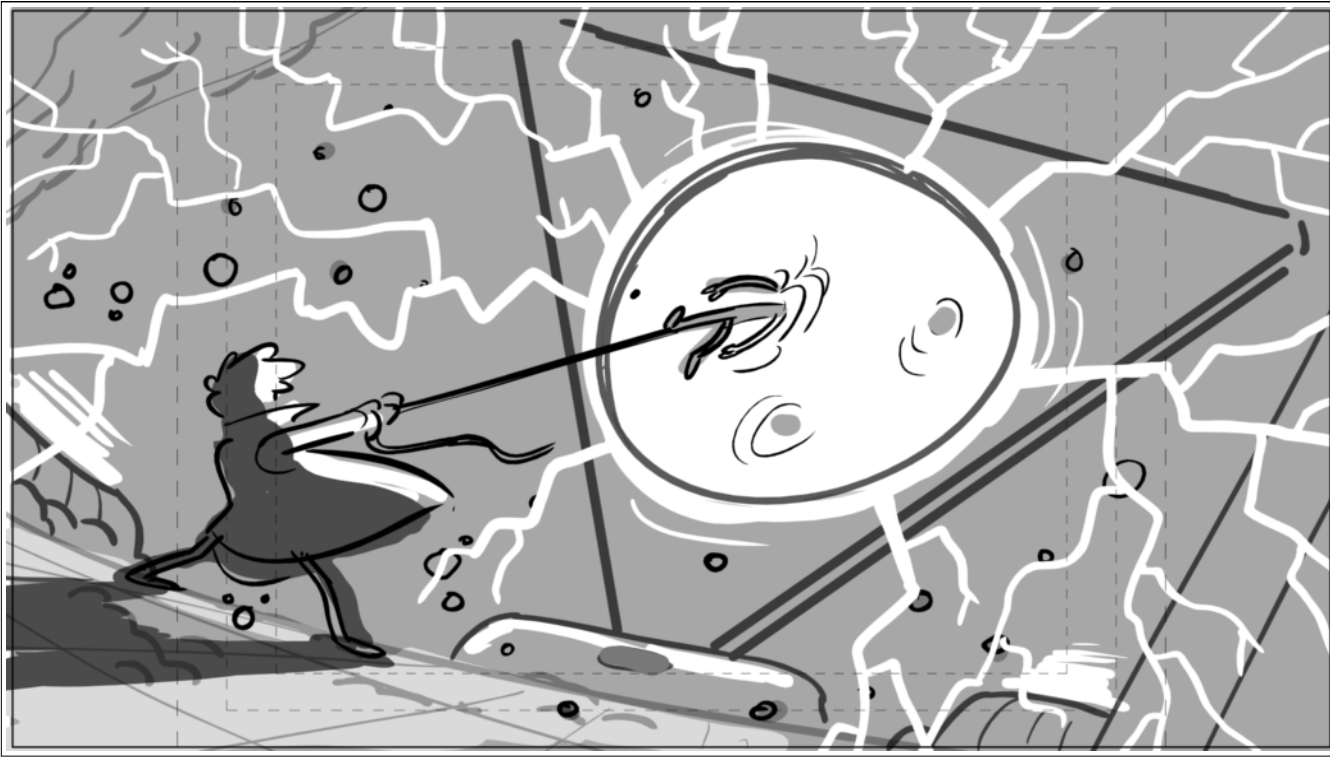

Action Notes

Dialog

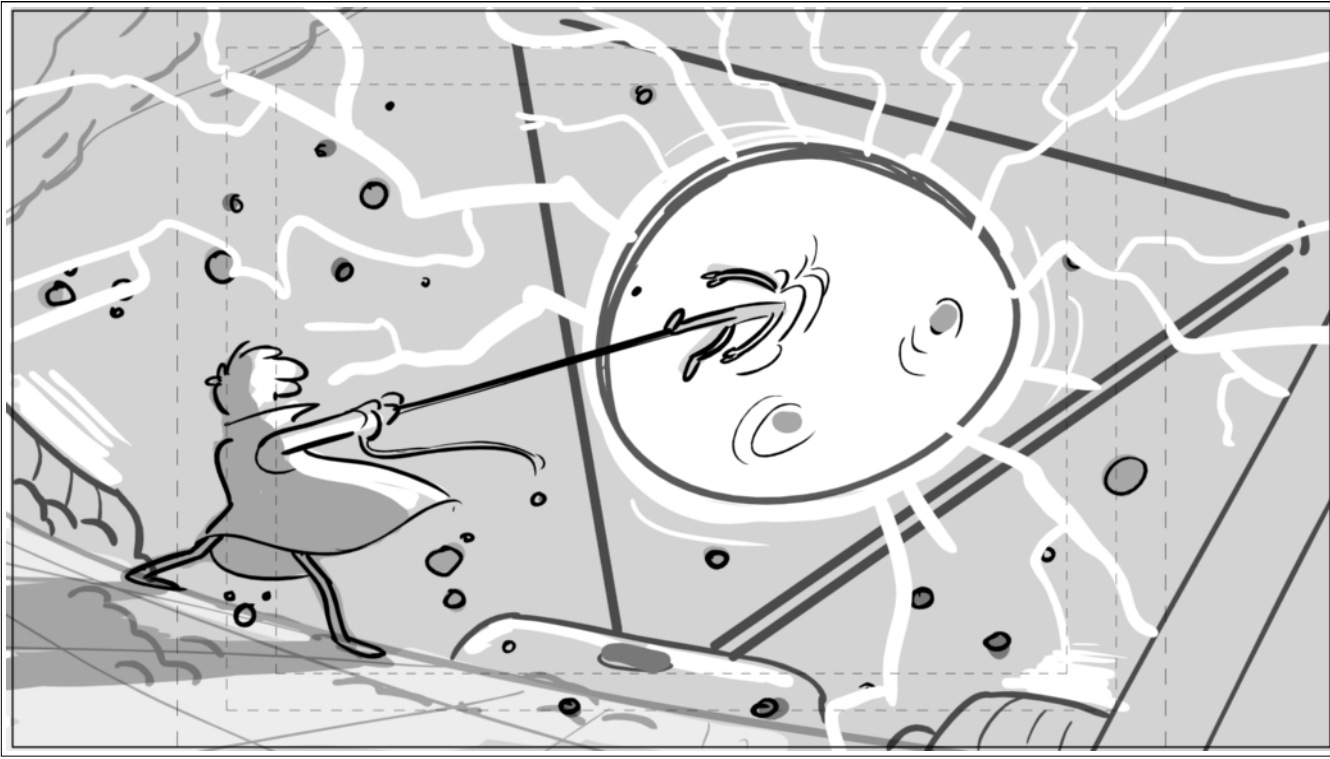

Action Notes

Dialog

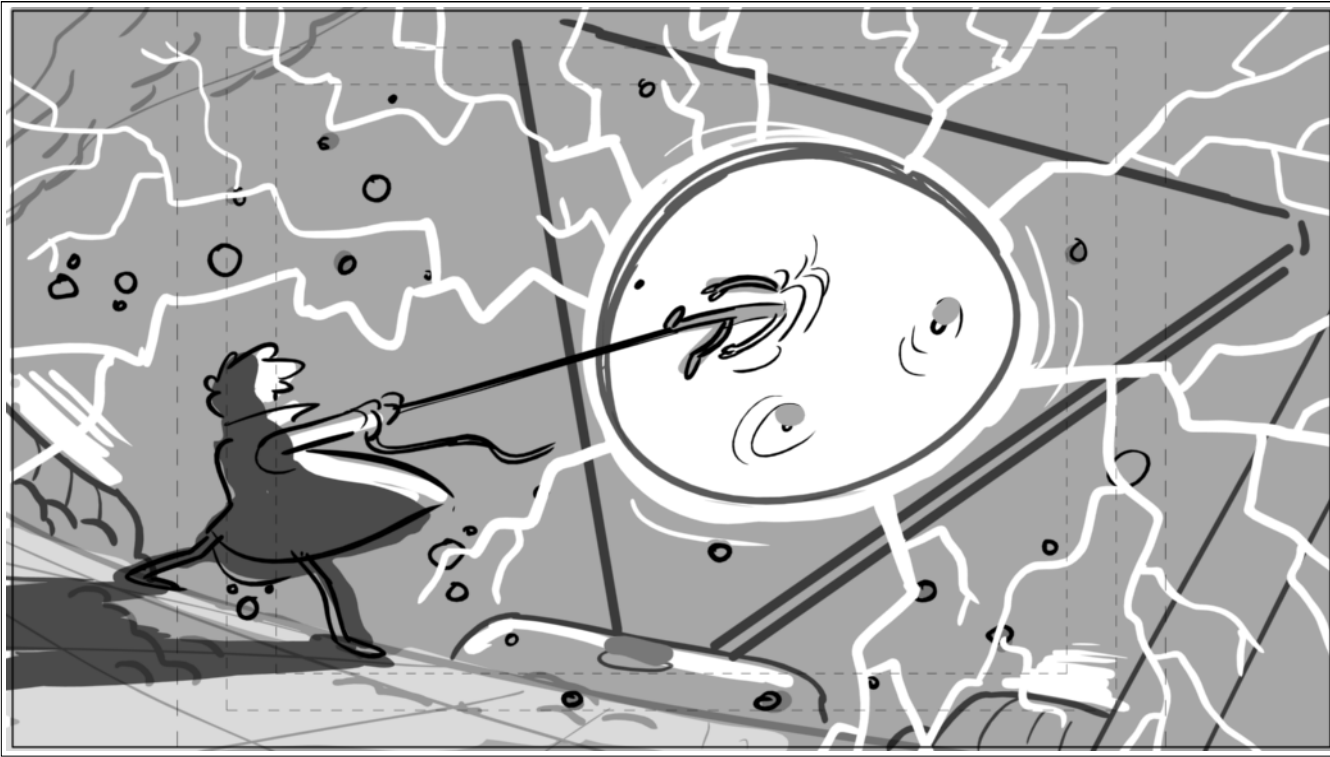

Action Notes

Dialog



Action Notes

Dialog

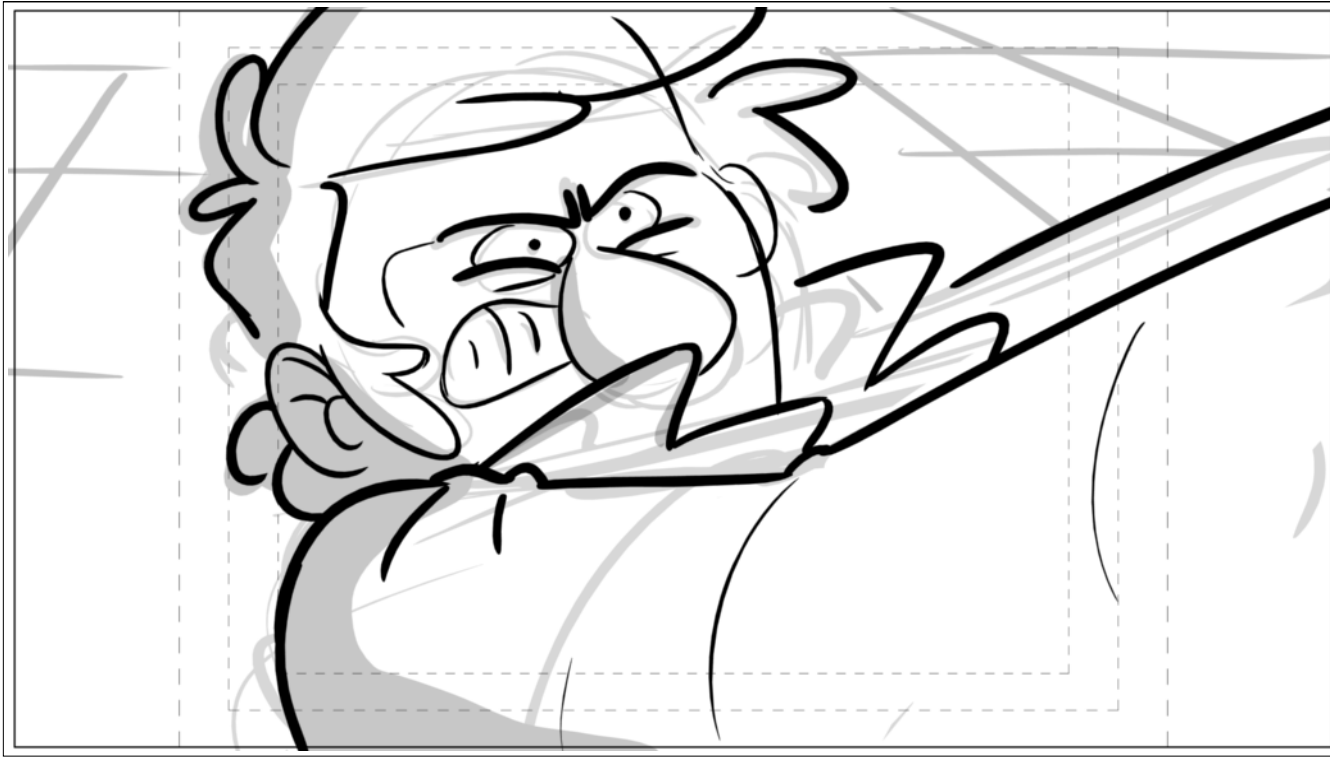

Action Notes

Dialog

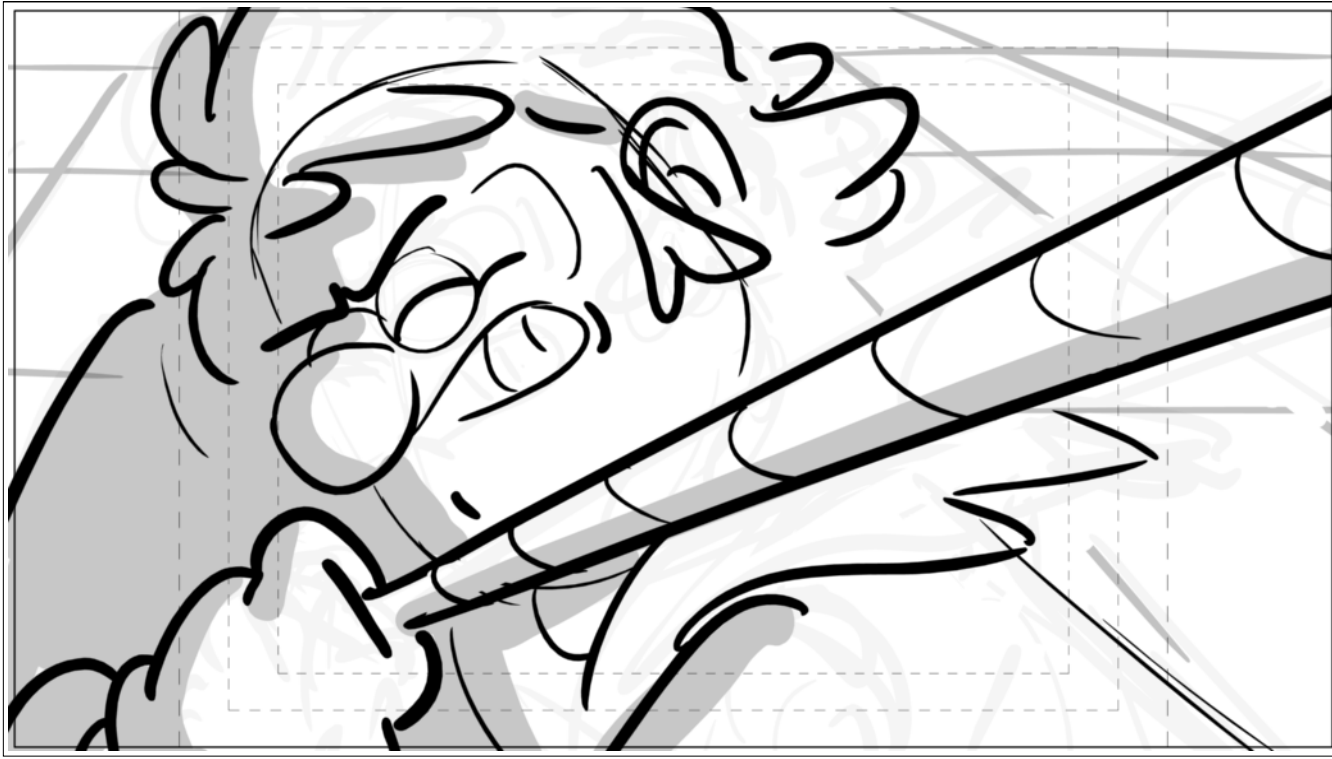

Action Notes

Dialog

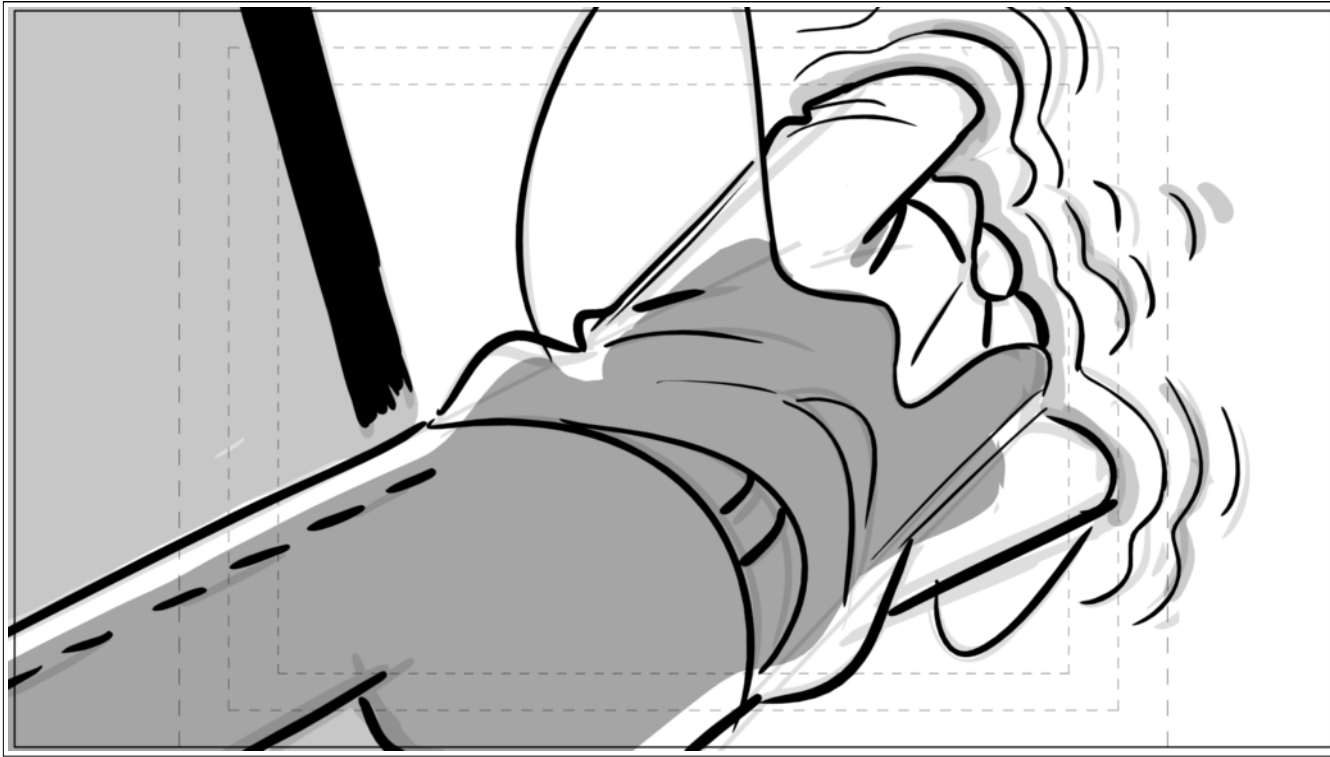

Action Notes

Dialog



Action Notes

---

Dialog



Action Notes

Dialog

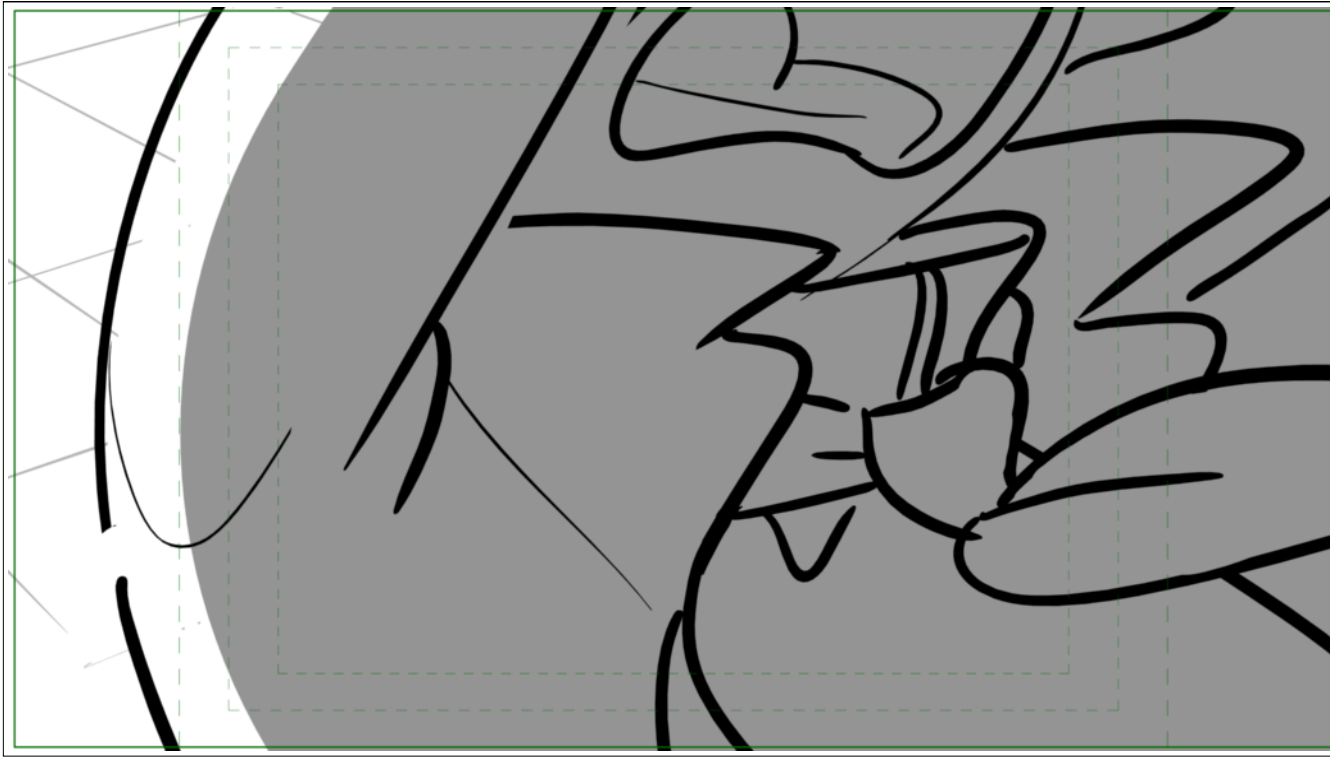

Action Notes

---

Dialog

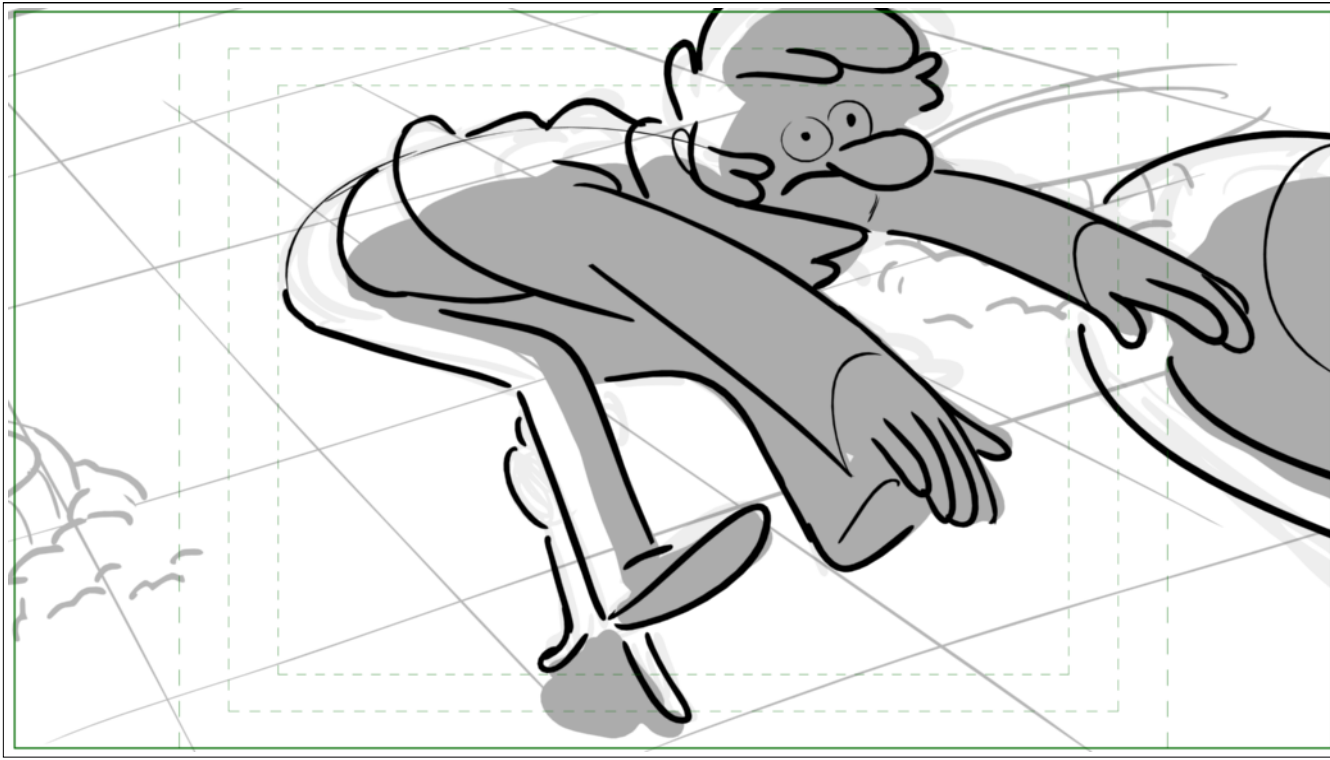

Action Notes

Dialog

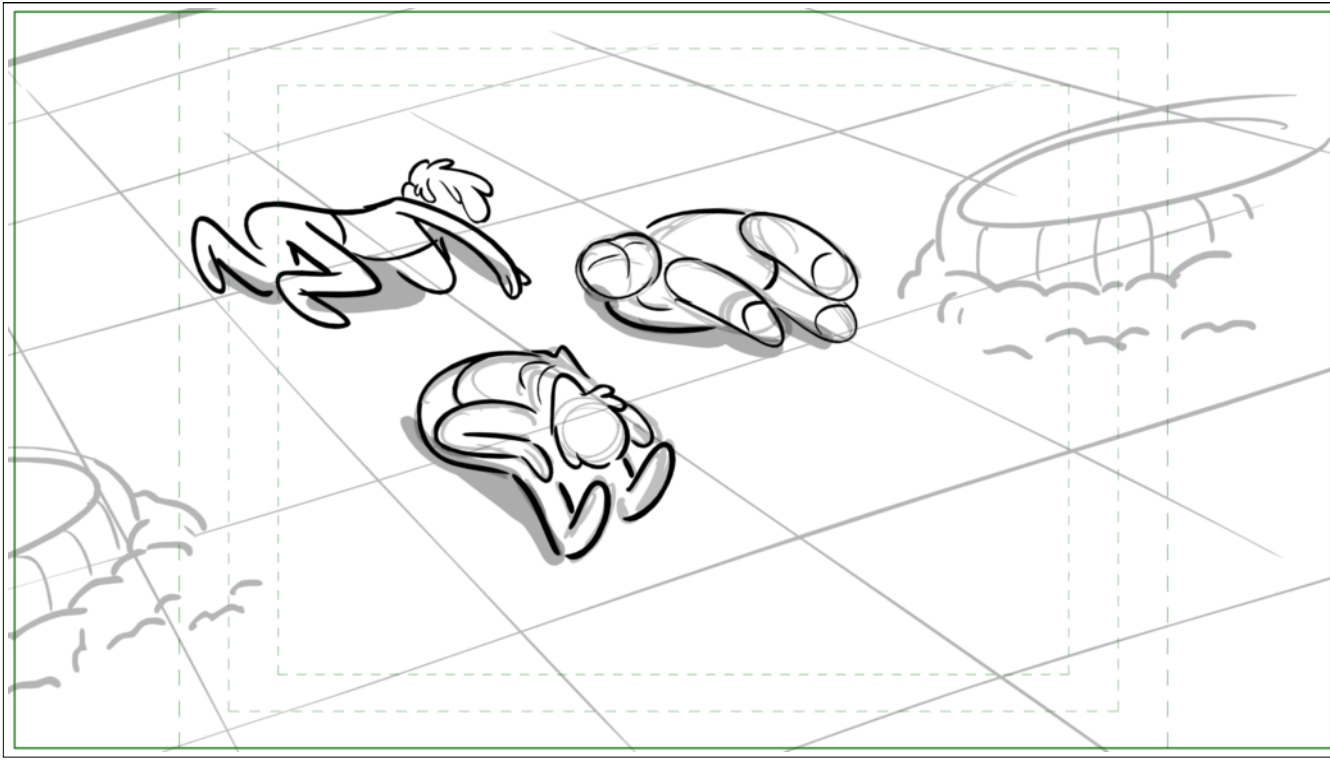

Action Notes

Dialog

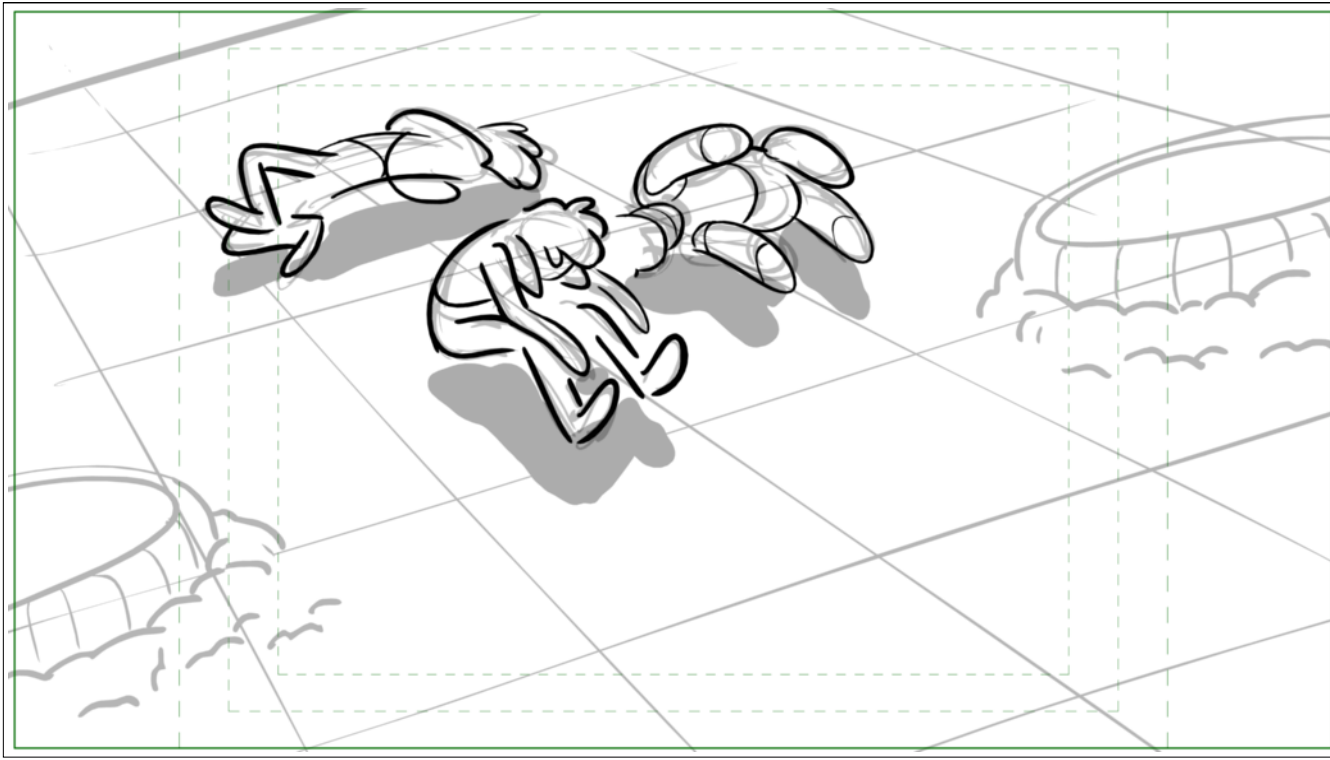

Action Notes

Dialog

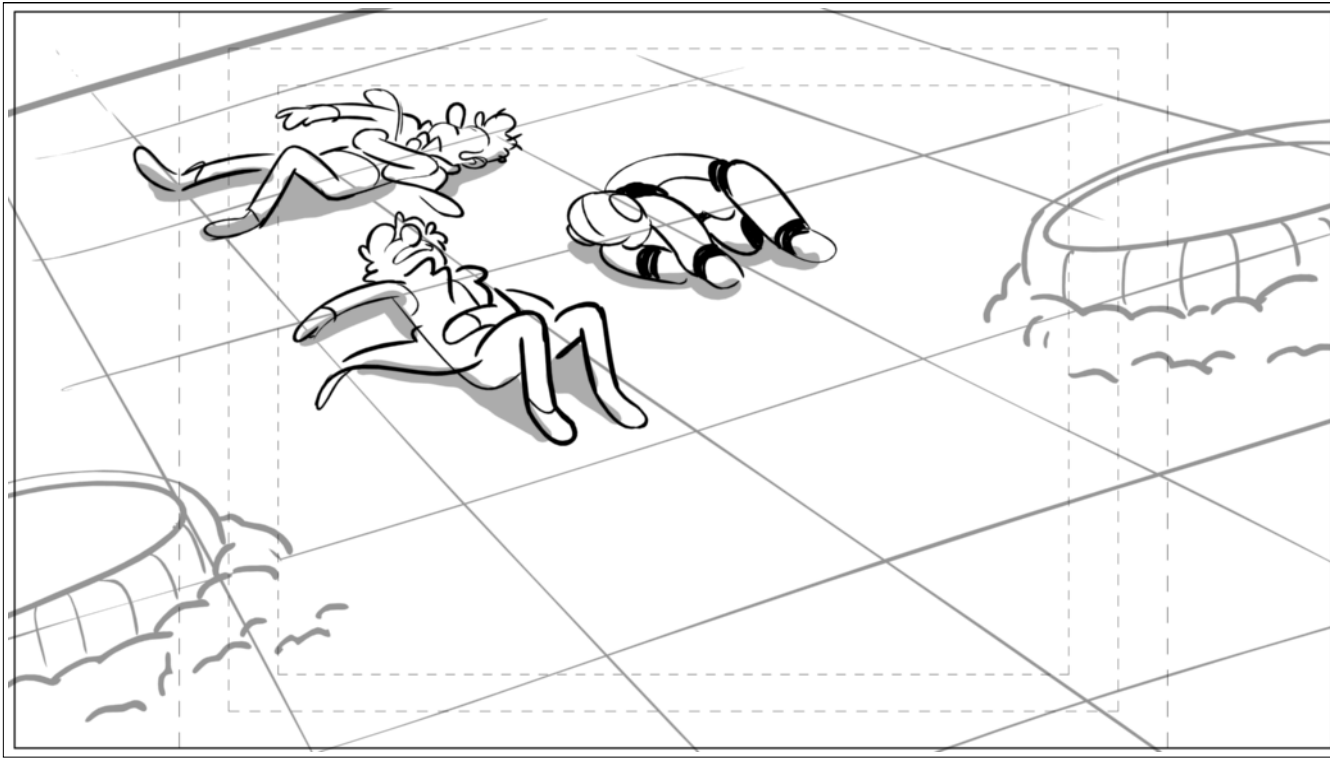

Action Notes

Dialog



Action Notes

Dialog



Action Notes

Dialog



Action Notes

Dialog

FORD: What is it??

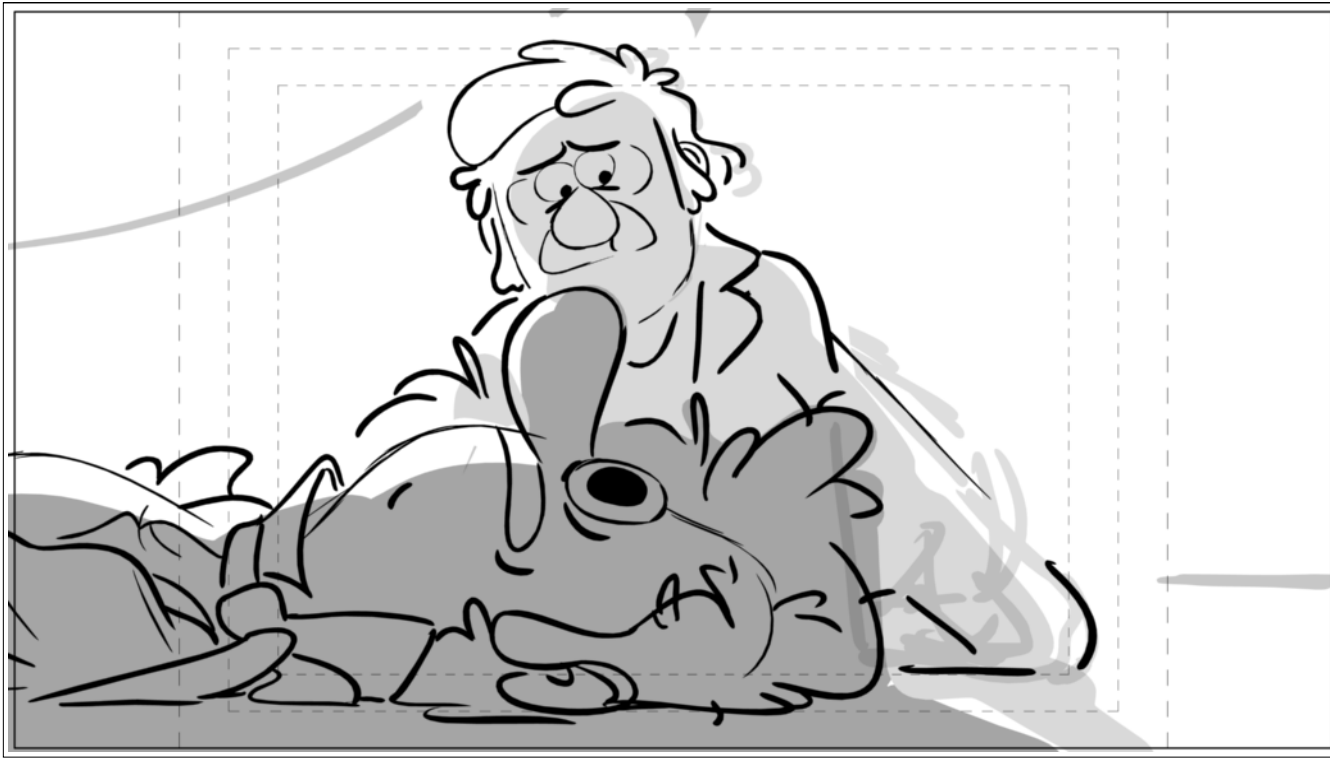

Action Notes

Dialog

Is it working?

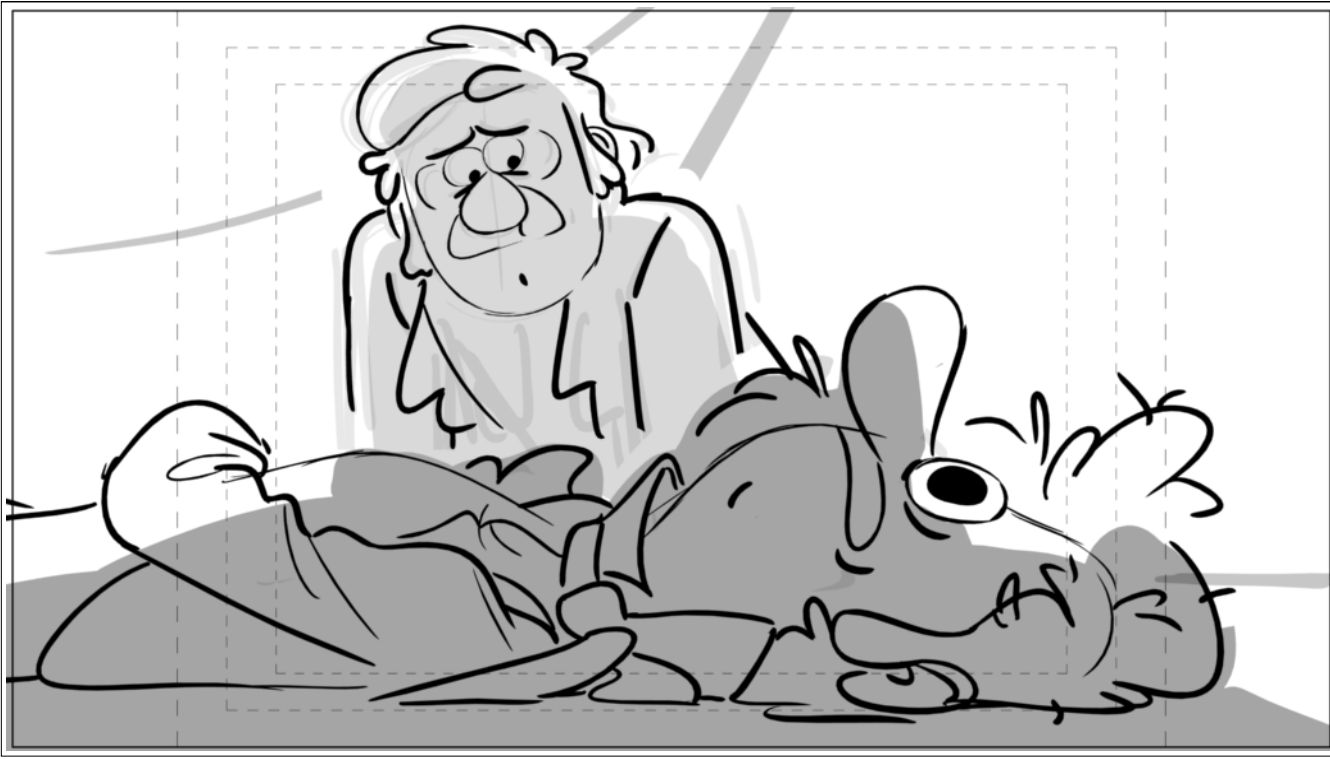

Action Notes

---

Dialog

What did you see??

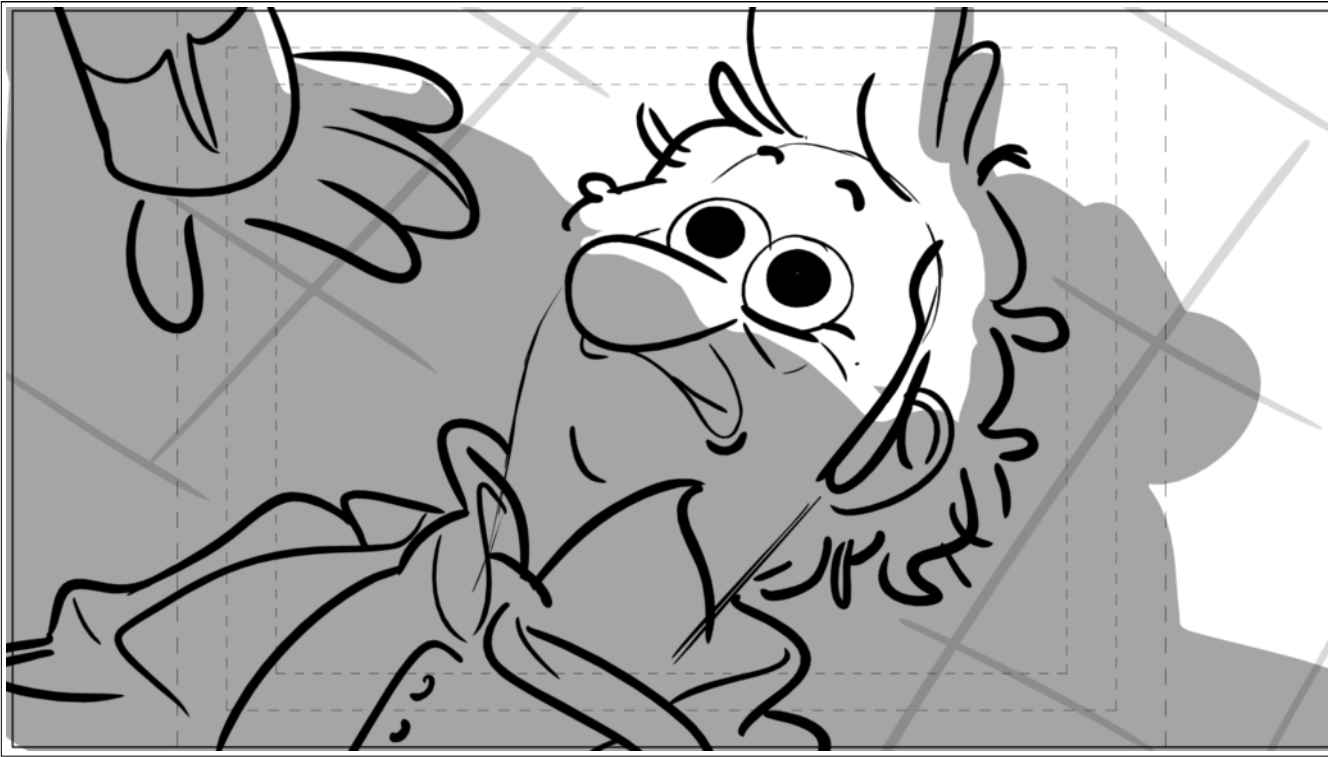

Action Notes

Dialog

FIDDLEFORD: A crawling hand.....

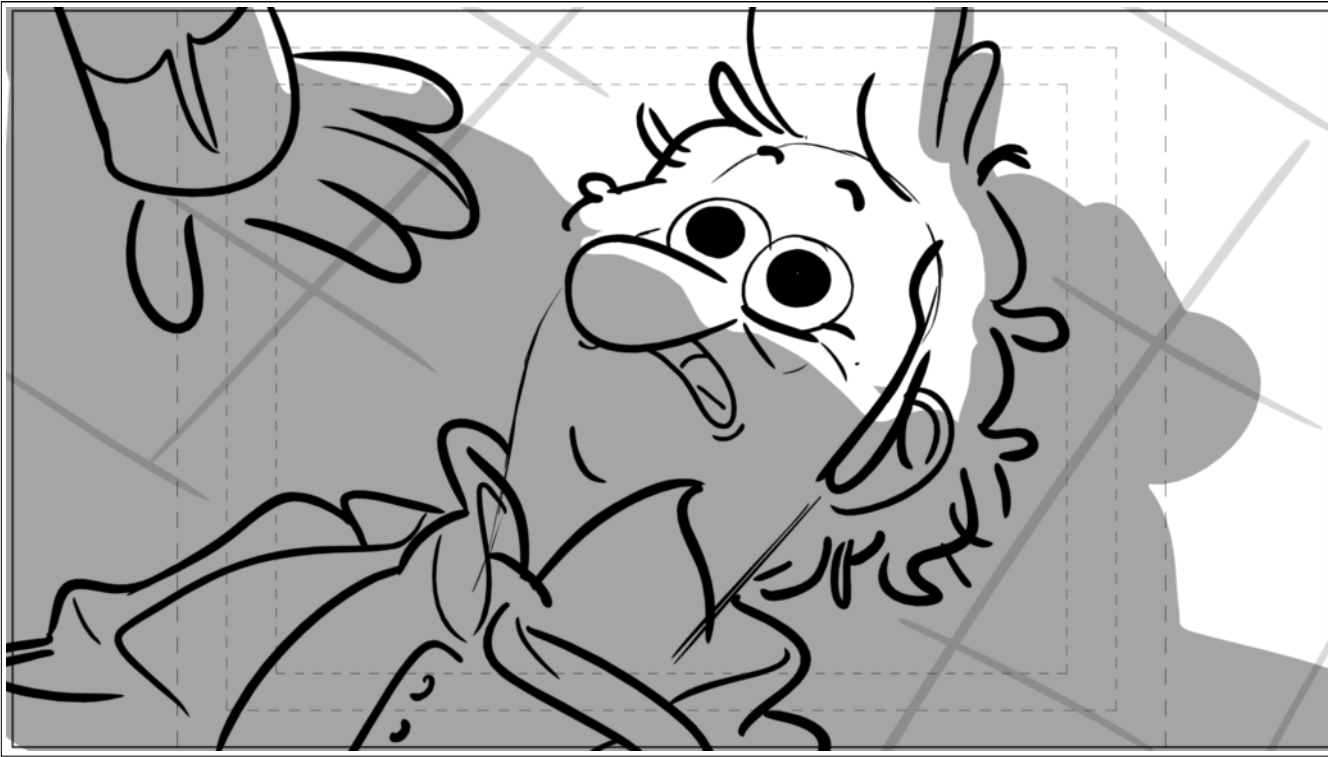

Action Notes

Dialog

FIDDLEFORD: A crawling hand.....

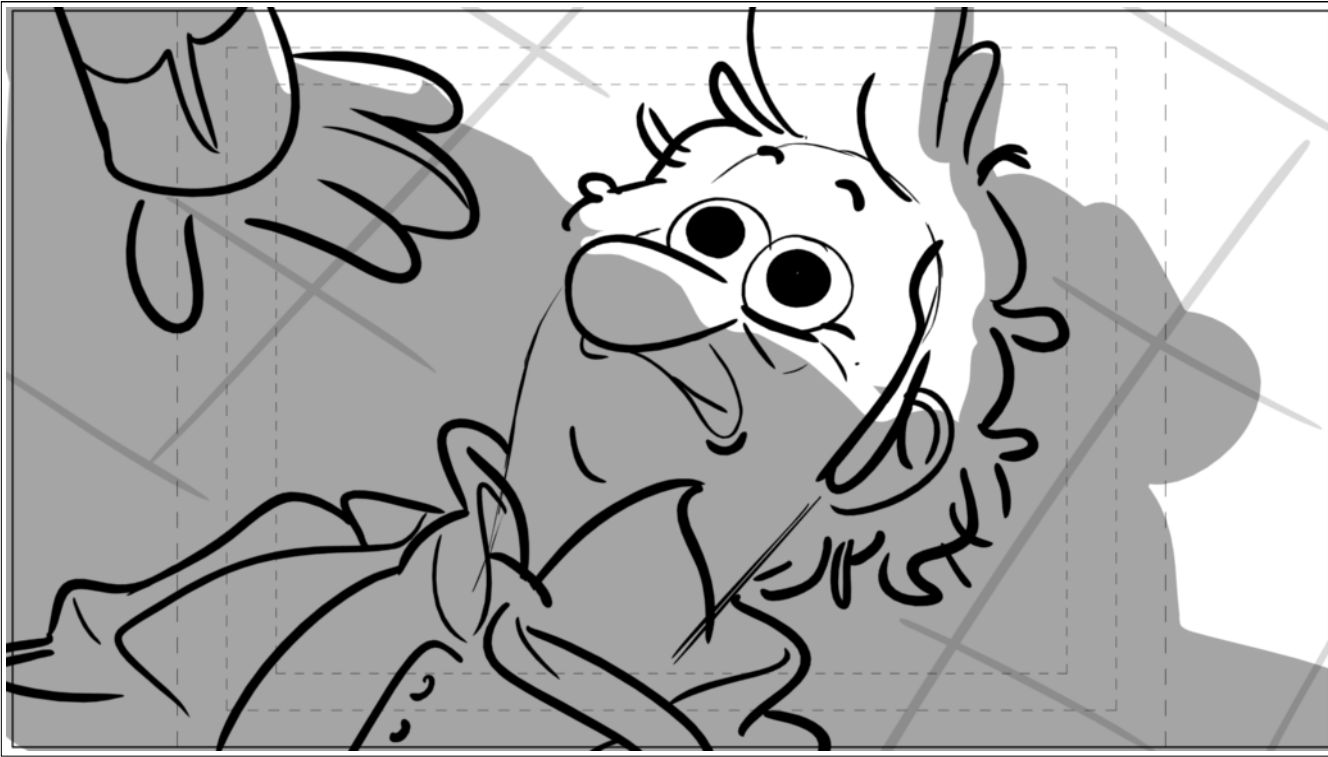

Action Notes

---

Dialog

a head with no face....



Action Notes

Dialog

a head with no face....

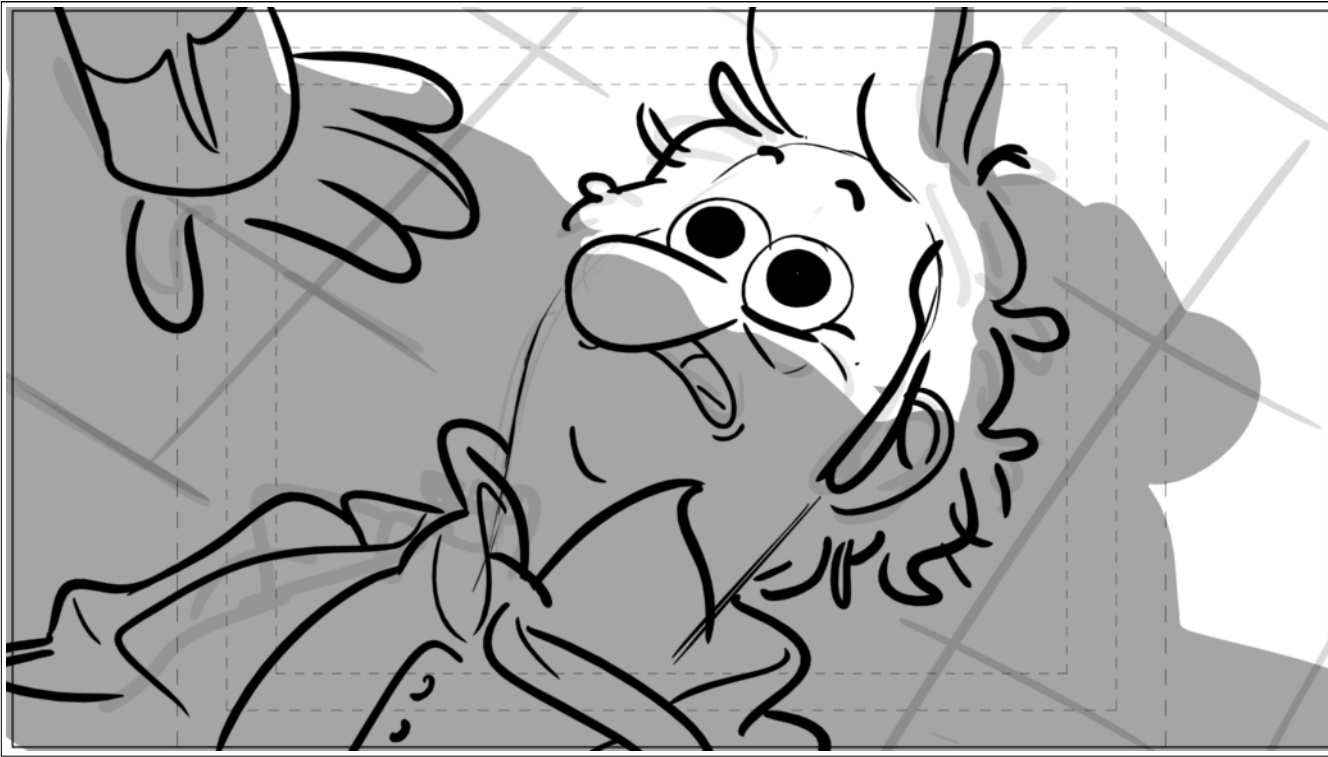

Action Notes

Dialog

(indecipherable backwards talking)



Action Notes

---

Dialog  
(indecipherable backwards talking)

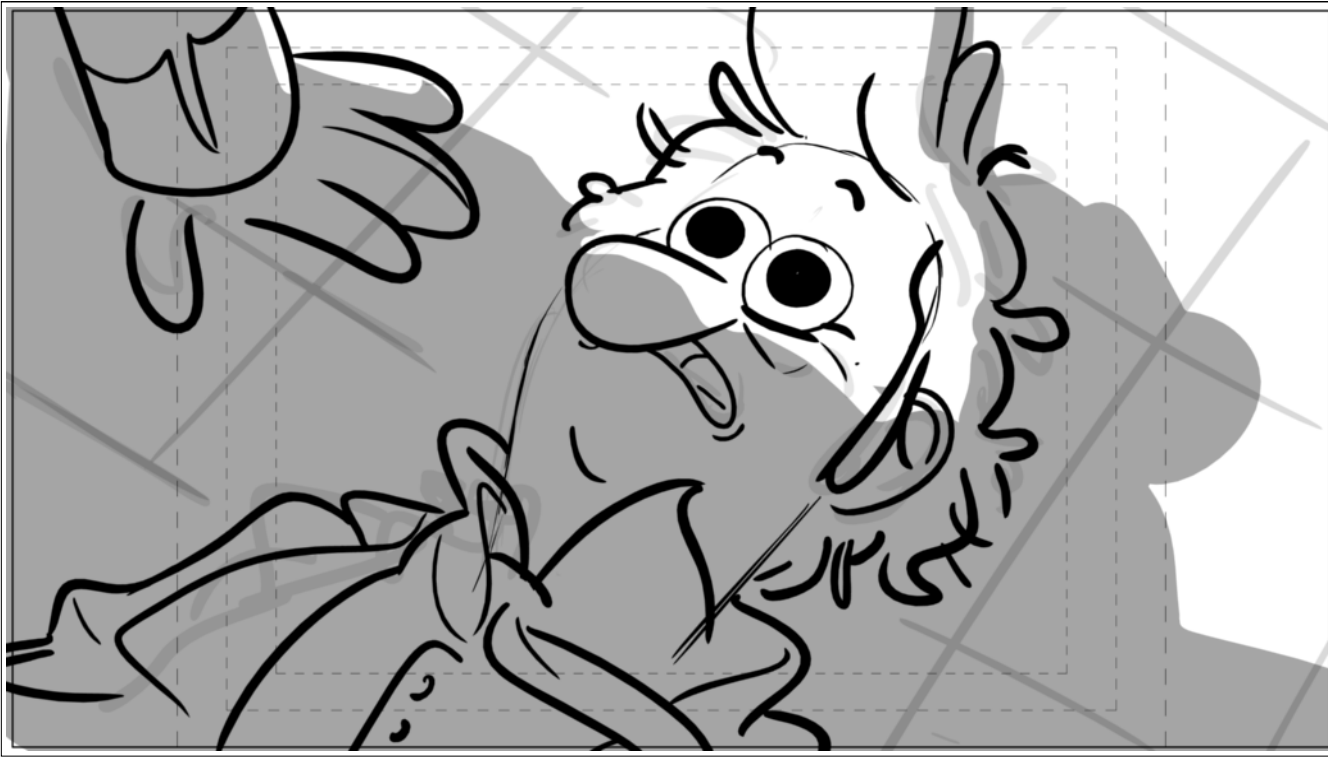

Action Notes

---

Dialog  
(indecipherable backwards talking)

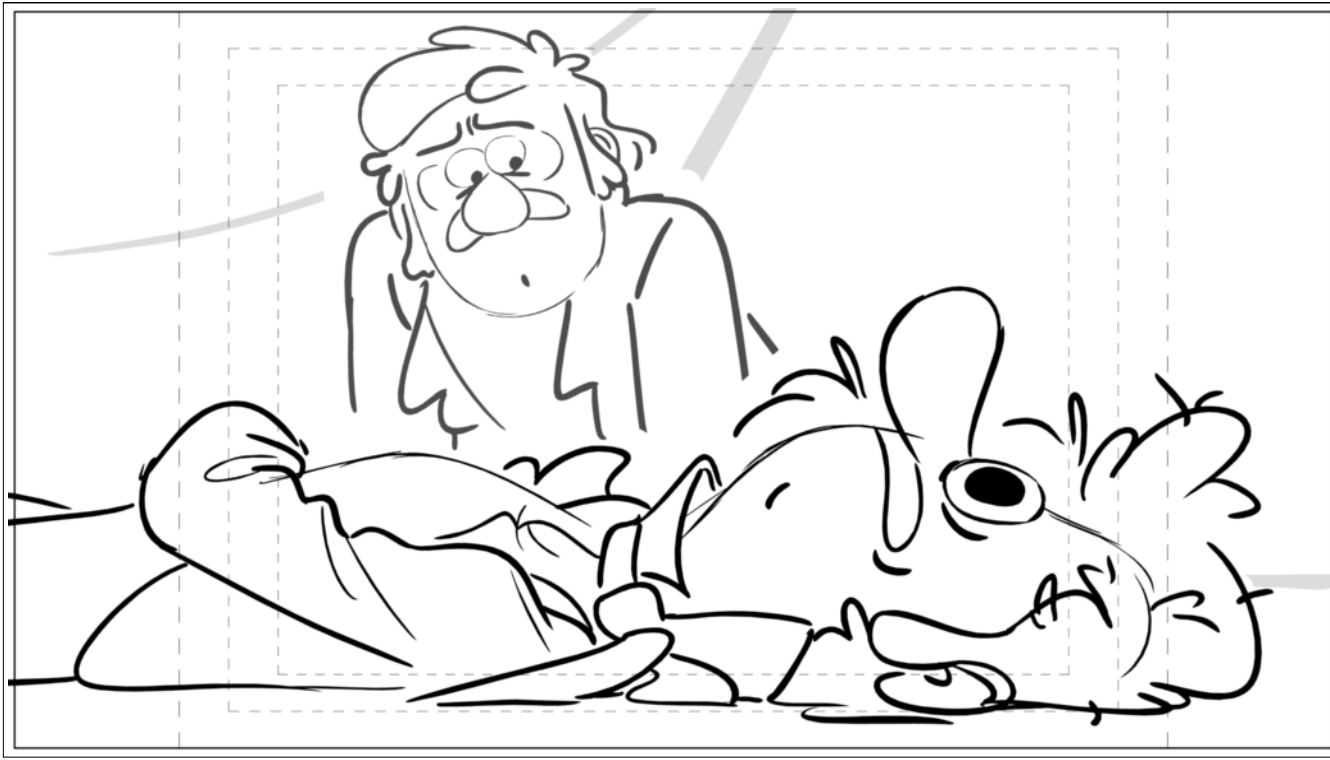

Action Notes

Dialog

FORD: Fiddleford?

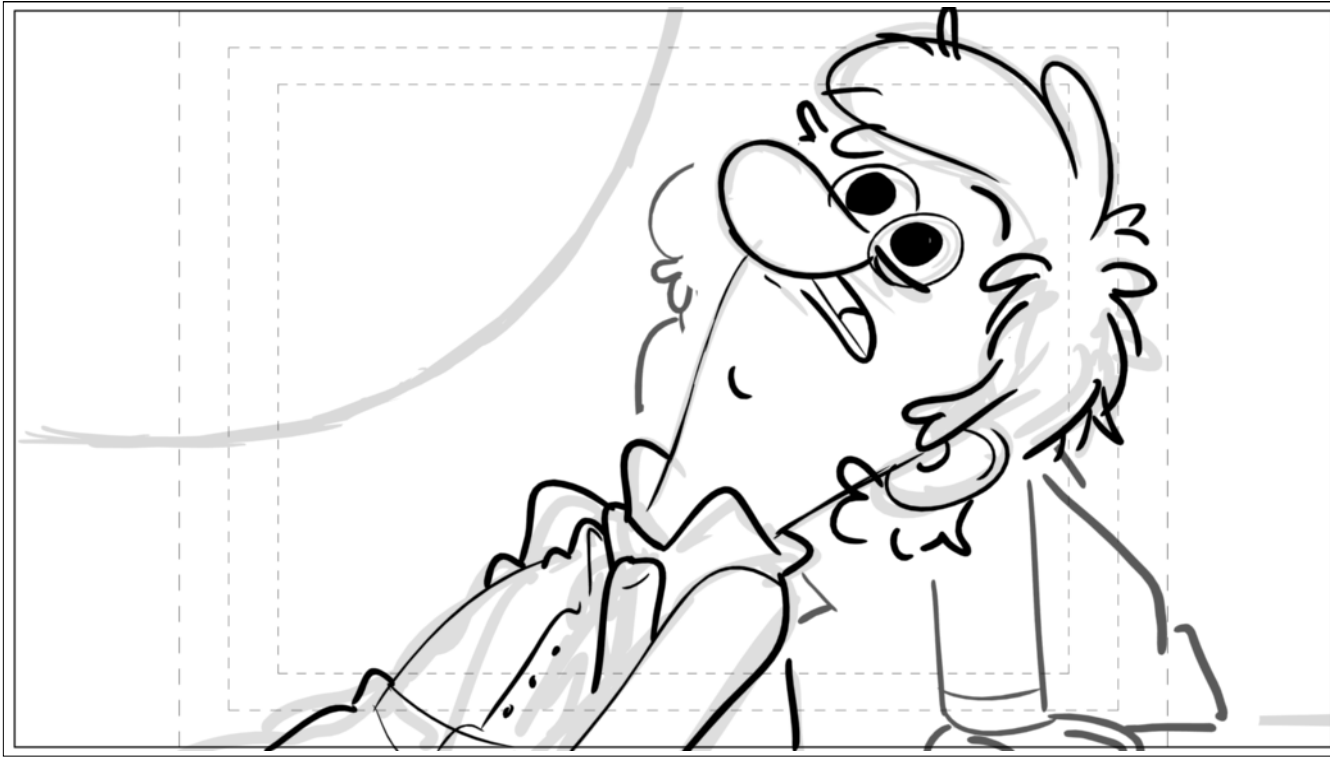

Action Notes

Dialog

FIDDLEFORD: When Gravity Falls



Action Notes

---

Dialog

FIDDLEFORD: When Gravity Falls



Action Notes

---

Dialog

and the Earth Becomes Sky, Fear the Beast with Just ONE EYE



Action Notes

---

Dialog

FORD: Fiddleford, get ahold of yourself!



Action Notes

---

Dialog

you're not making



Action Notes

---

Dialog  
any sense!



Action Notes

Dialog



Action Notes

Dialog



Action Notes

Dialog

FIDDLEFORD: I saw things which no man aught-



Action Notes

Dialog

this machine is



Action Notes

---

Dialog  
dangerous, Stanford.



Action Notes

Dialog

You will bring about the



Action Notes

Dialog

end of the world with this!

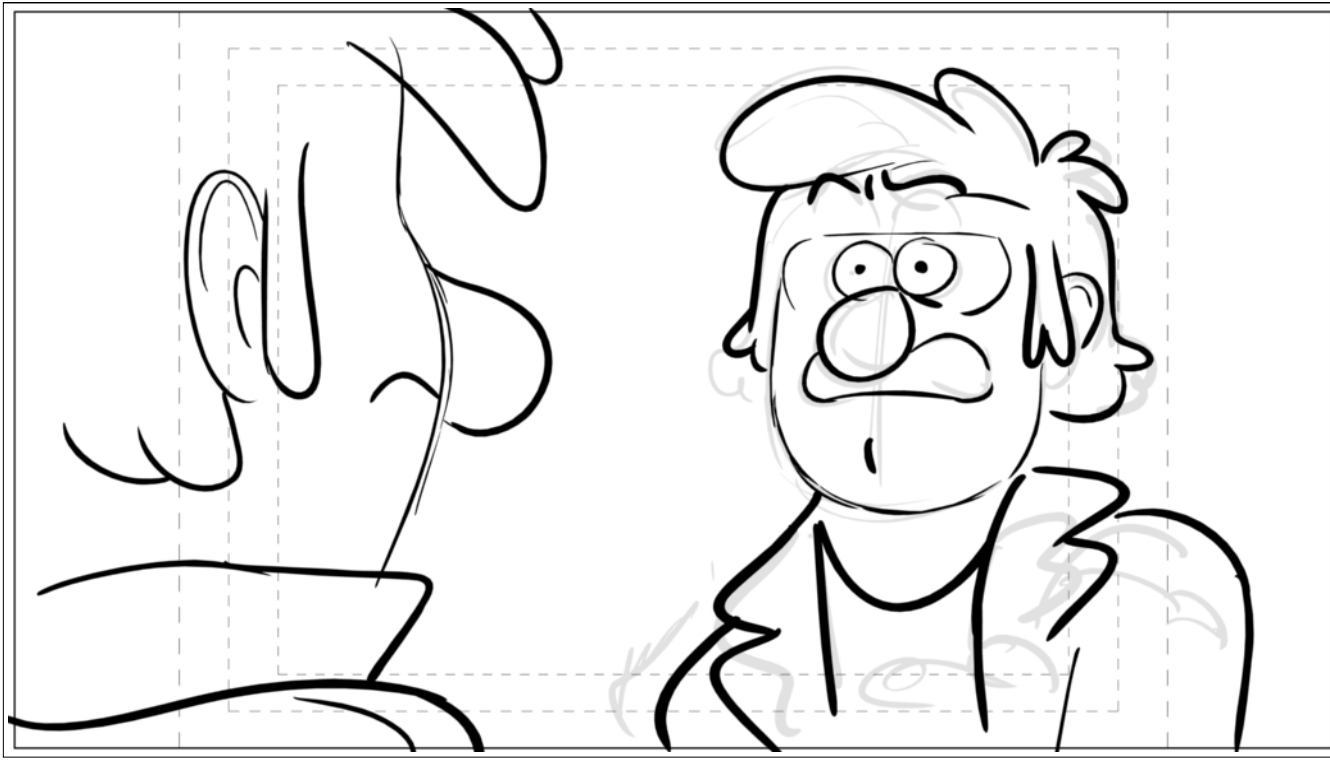

Action Notes

Dialog

FORD: What?!



Action Notes

Dialog

Listen, you just have



Action Notes

Dialog

dimensional travel sickness....



Action Notes

Dialog

FIDDLEFORD: You're



Action Notes

---

Dialog

the one with the sickness!



Action Notes

Dialog

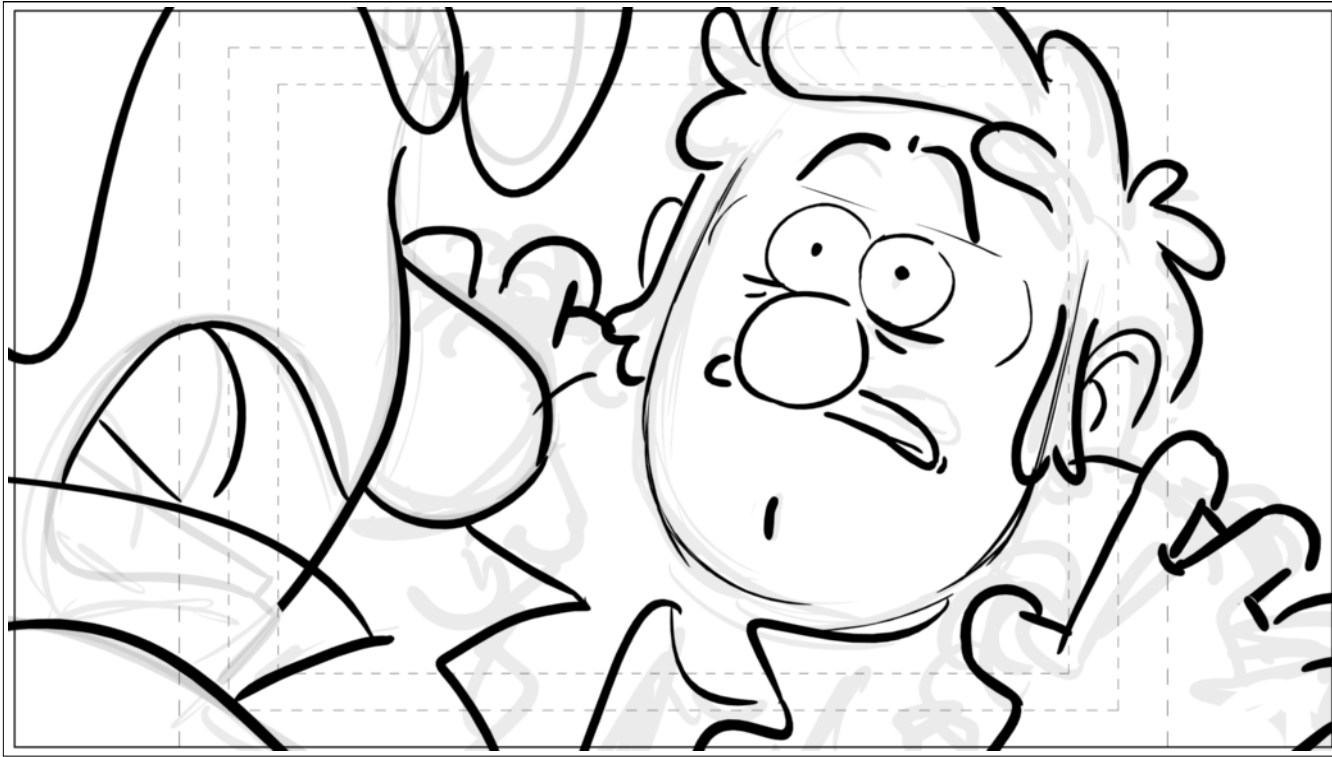

Action Notes

Dialog



Action Notes

Dialog

This machine will be



Action Notes

---

Dialog  
your doom!

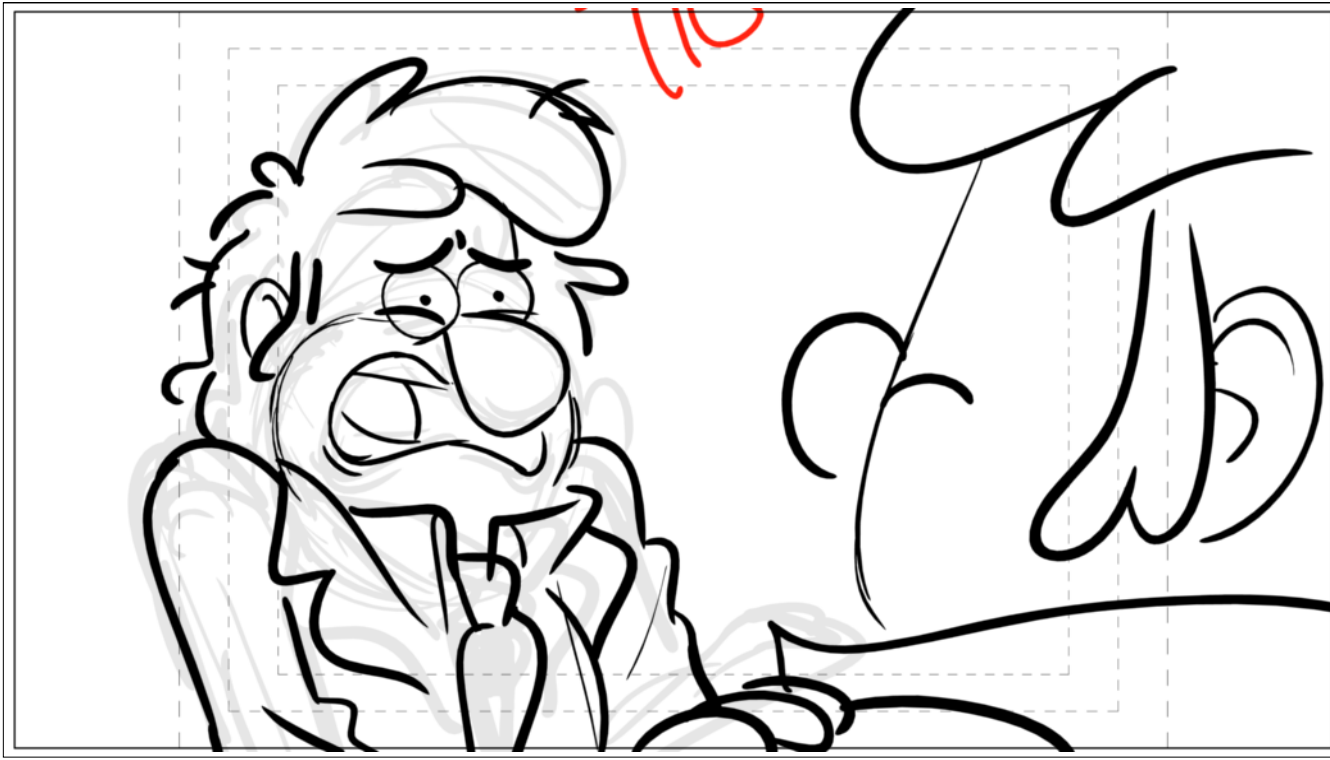

Action Notes

Dialog

Destroy it before it destroys us all!



Action Notes

Dialog

If you have

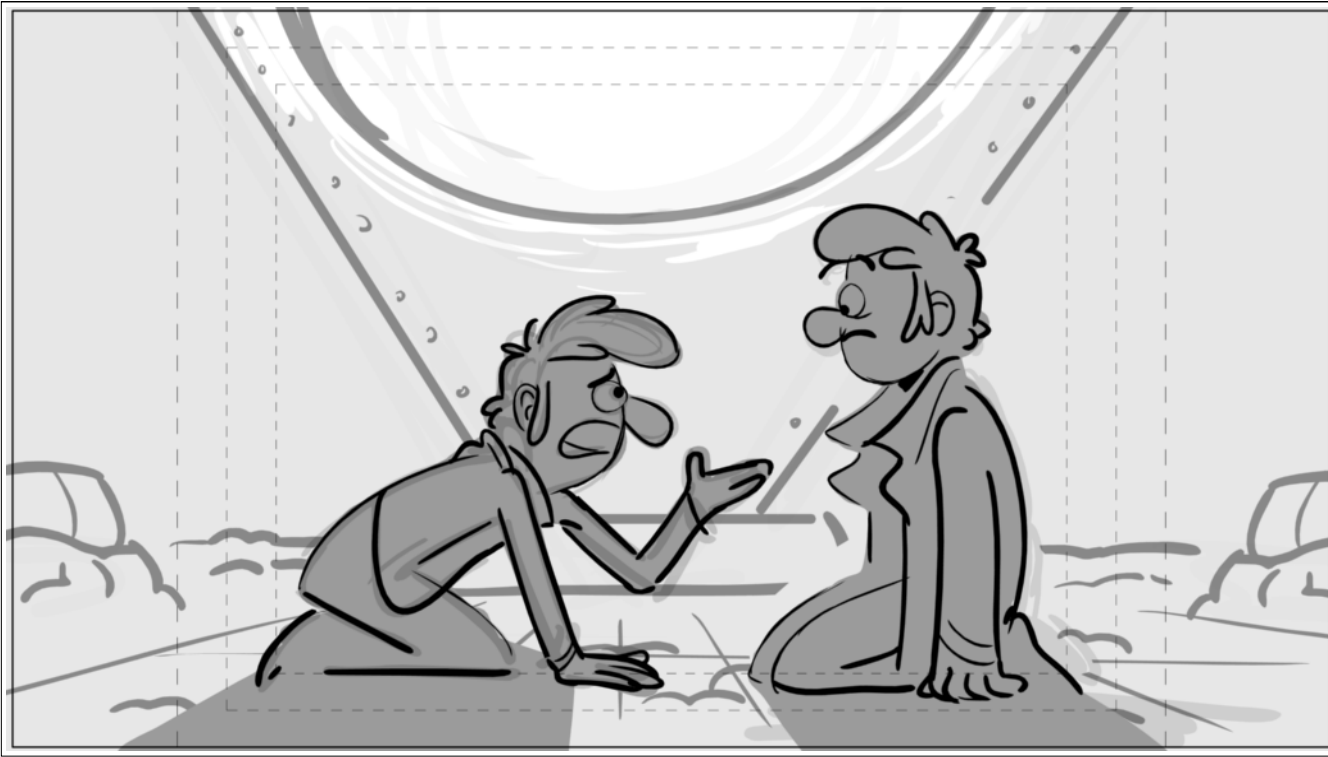

Action Notes

Dialog

any sense at all you'll



Action Notes

---

Dialog  
quit this project.



Action Notes

Dialog

I fear we've unleashed a grave danger on the world.



Action Notes

Dialog

One I'd just as soon forget.



Action Notes

Dialog

One I'd just as soon forget.



Action Notes

Dialog  
I quit.

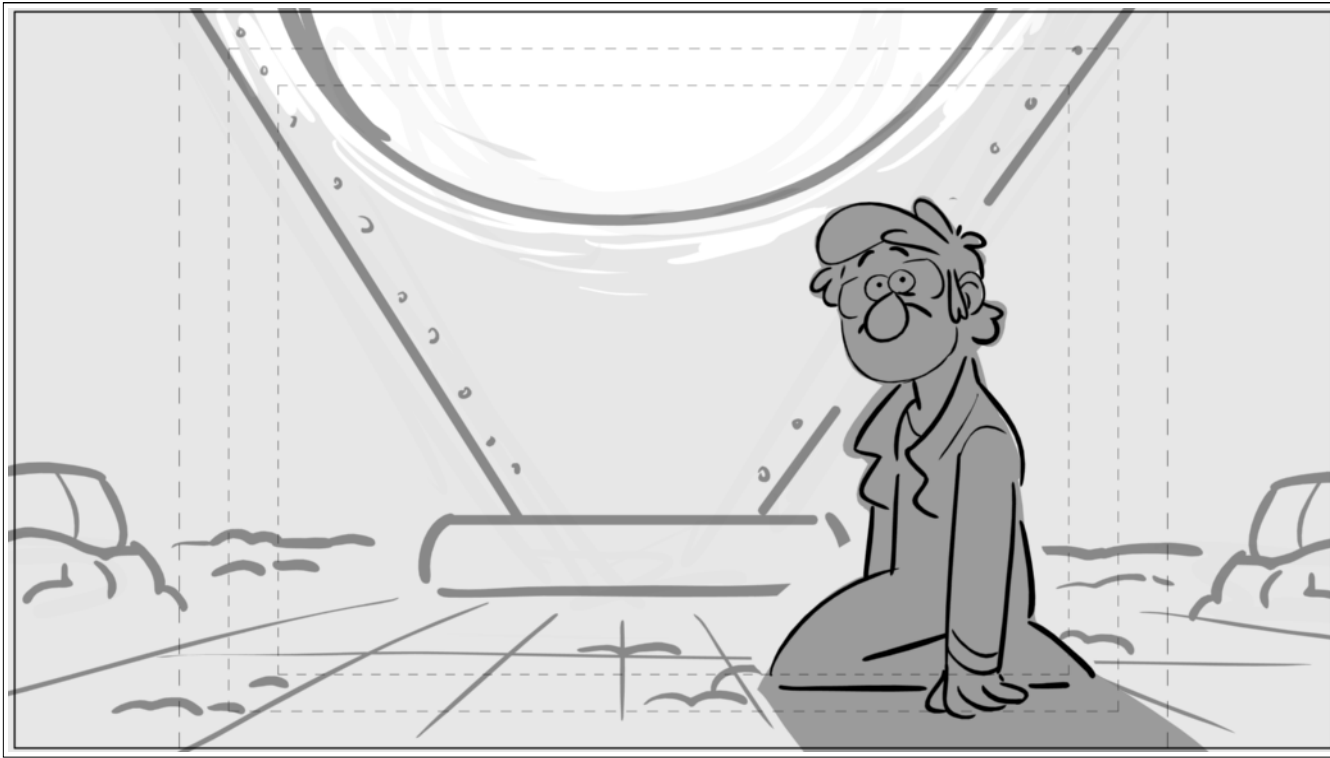

Action Notes

Dialog

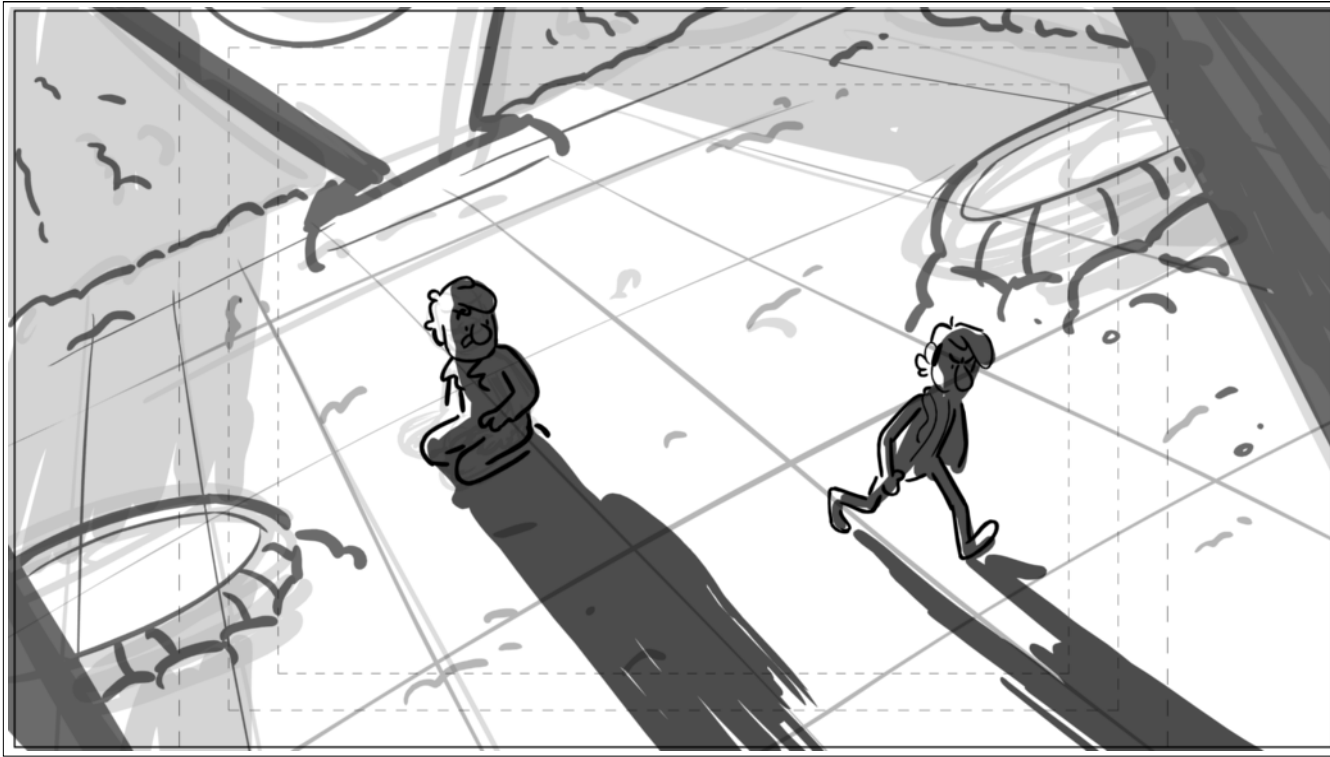

Action Notes

Dialog

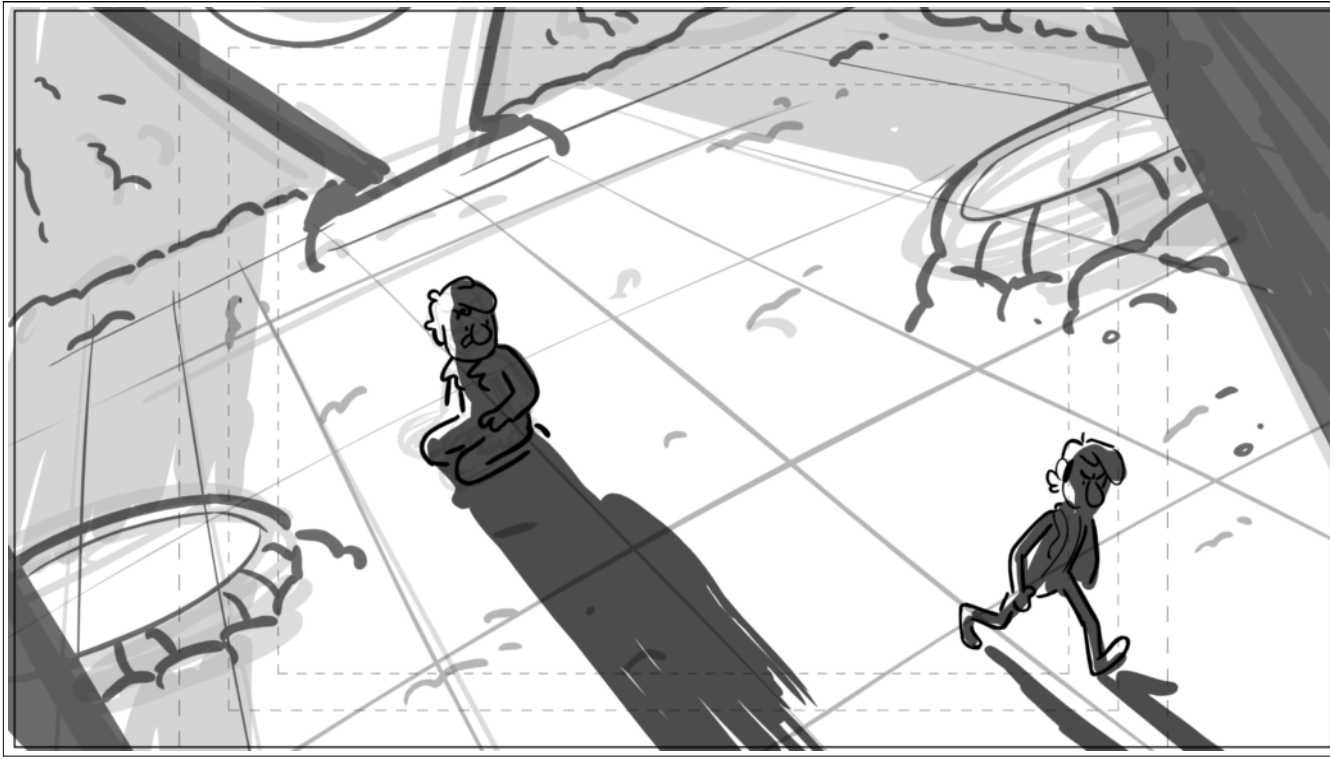

Action Notes

Dialog

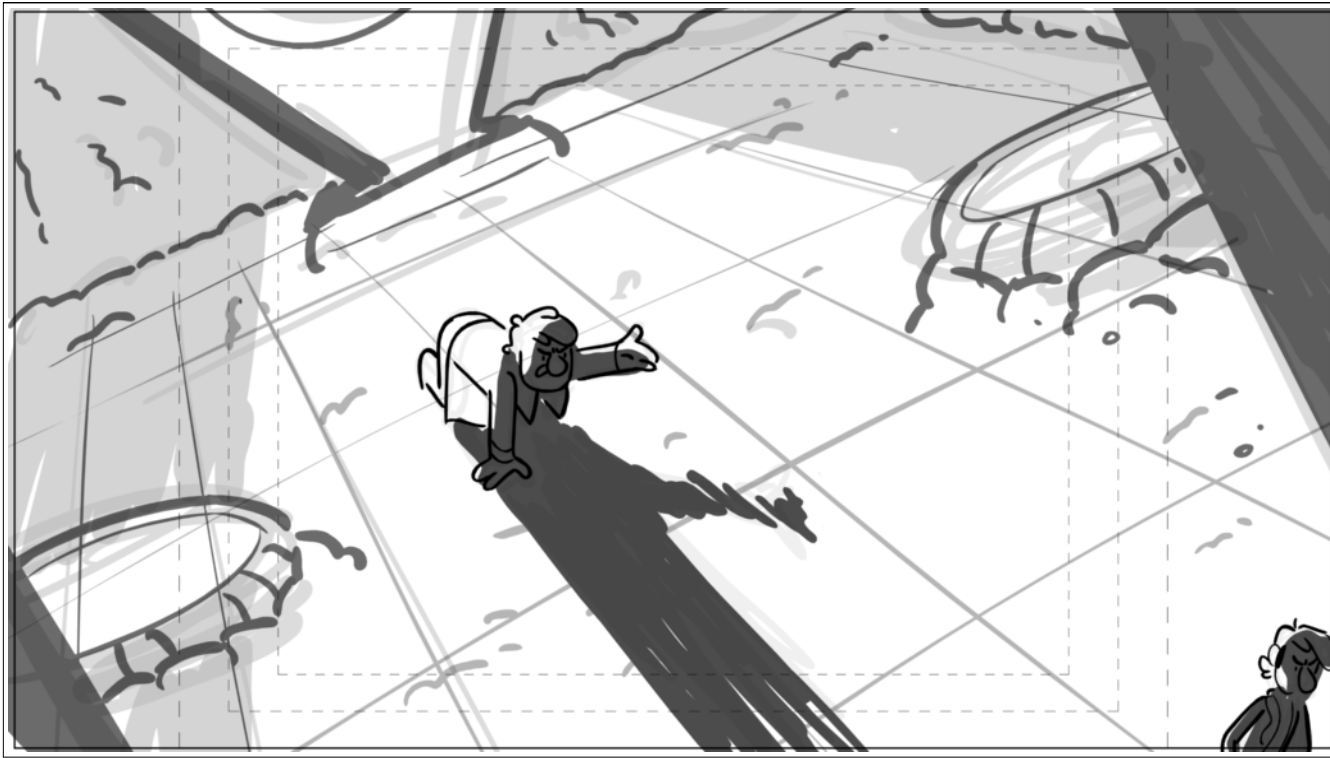

Action Notes

Dialog

FORD: FINE!

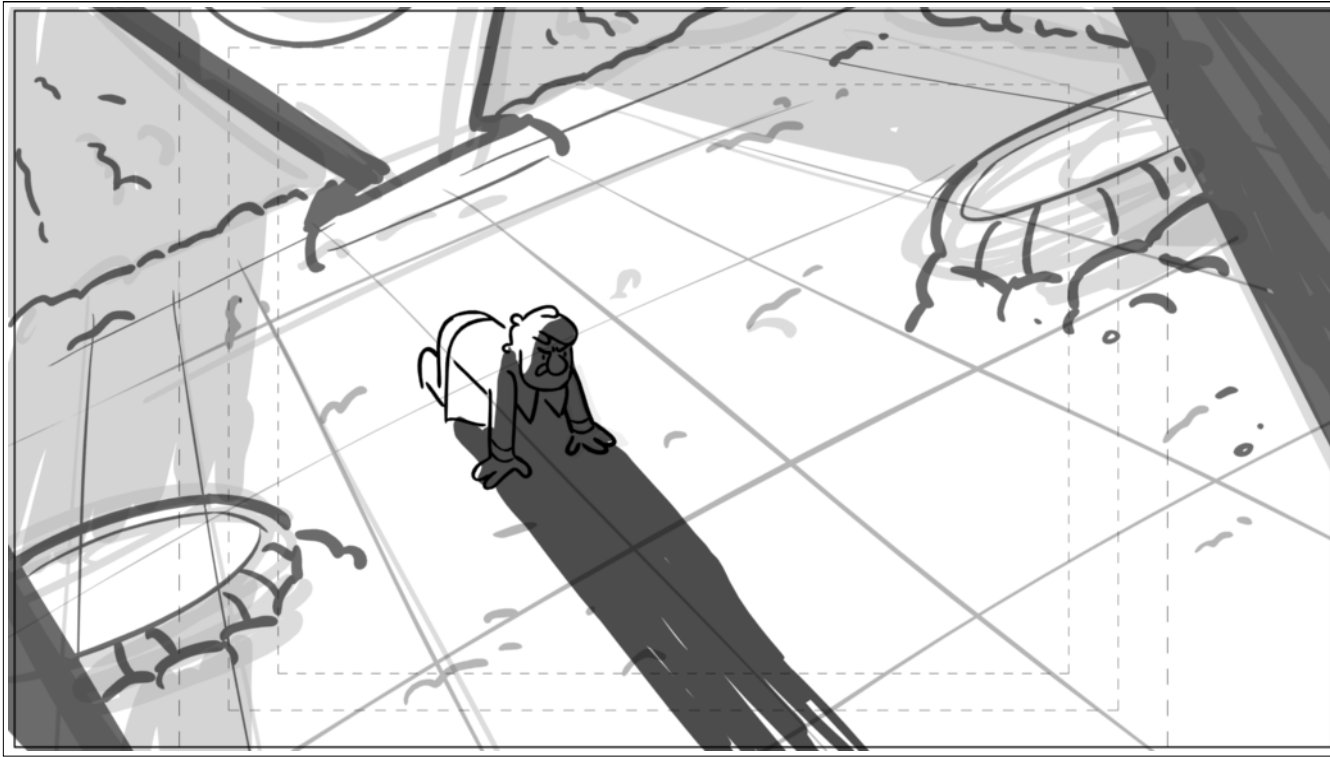

Action Notes

Dialog

I'll do it without you!



Action Notes

---

Dialog



Action Notes

---

Dialog  
(eerie whispering)



Action Notes

---

Dialog  
(eerie whispering)



Action Notes

---

Dialog  
(eerie whispering)



Action Notes

---

Dialog  
(eerie whispering)



Action Notes

---

Dialog

FORD: What?



Action Notes

---

Dialog

Who said that?!



Action Notes

---

Dialog