

# LAZIO 2000 X

INFORMATION SHEET

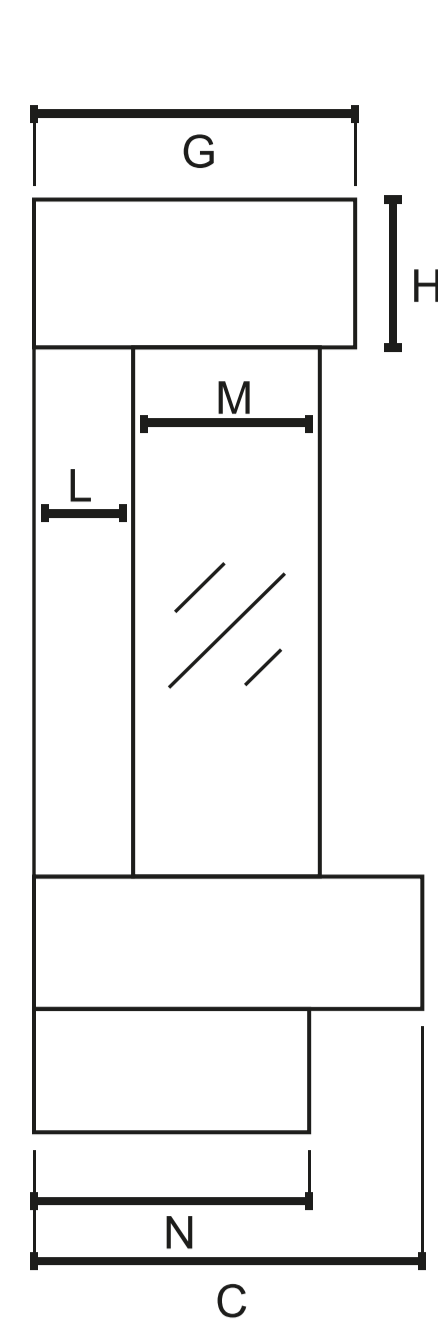

## DIMENSIONS

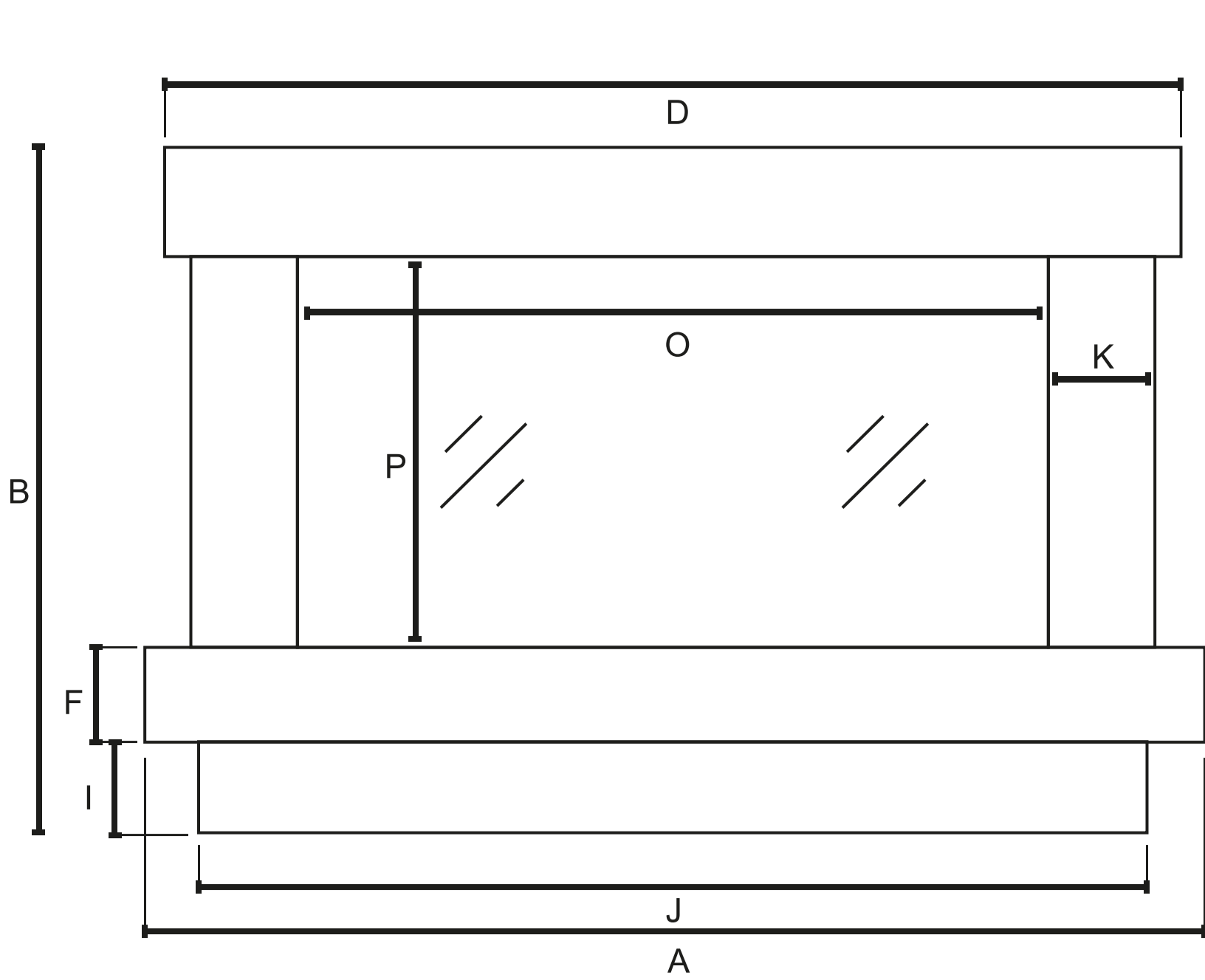

SIZES	
A 2337mm	B 784mm
C 410mm	D 2237mm
E 254mm	F 152mm
G 381mm	H 114mm
I 102mm	J 2237mm
K 87mm	L 100mm
M 195mm	N 360mm
O 2000mm	P 416mm

## AVAILABLE IN 4 SIZES



LAZIO 1250



LAZIO 1500



LAZIO 2000



LAZIO 2500

## CHOOSE YOUR MARBLE

Our exquisite range of suites are available in a vast range of naturally beautiful stones. Choose to have your Bespoke electric suite crafted in one beautiful colour, or step outside your comfort zone and add in a second 'highlight' stone to complement your 'primary' choice.

See something in store you like? Speak to your sales advisor for more information on showroom exclusive marbles

### CLASSIC STONE COLLECTION

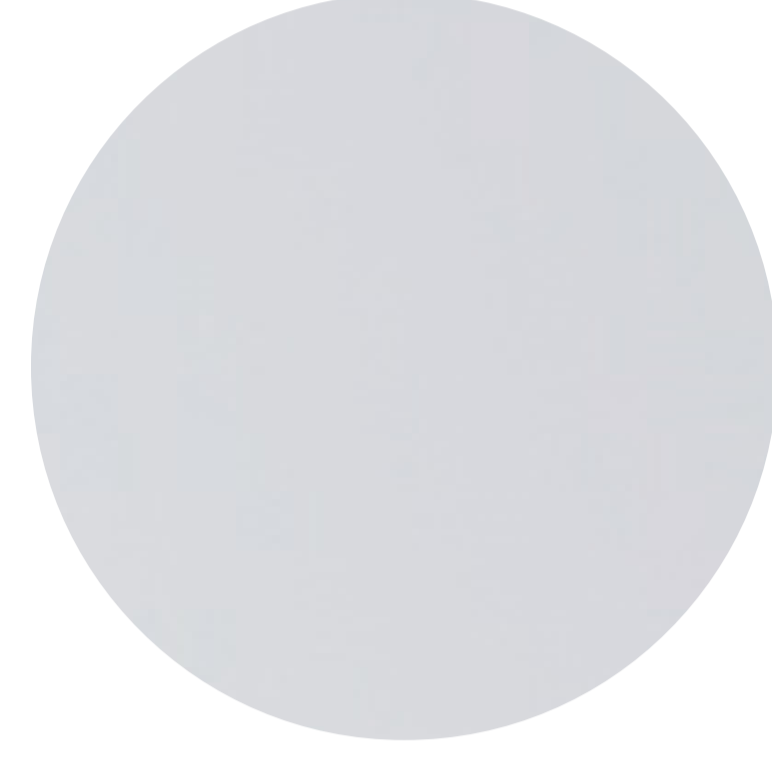

POLAR WHITE



SEMI RIJO



CALACATTA



NACARADO

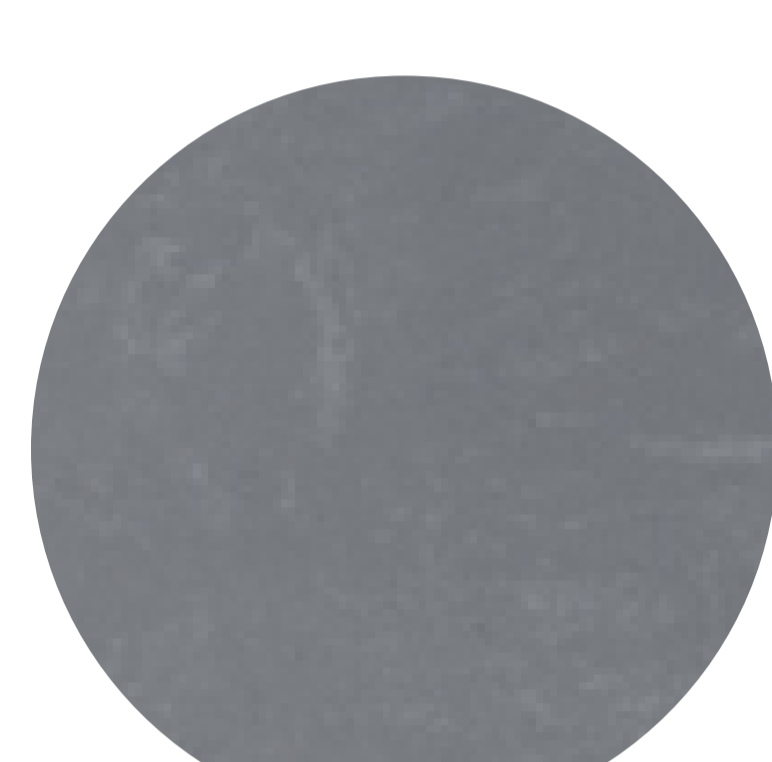

ITALIAN GREY

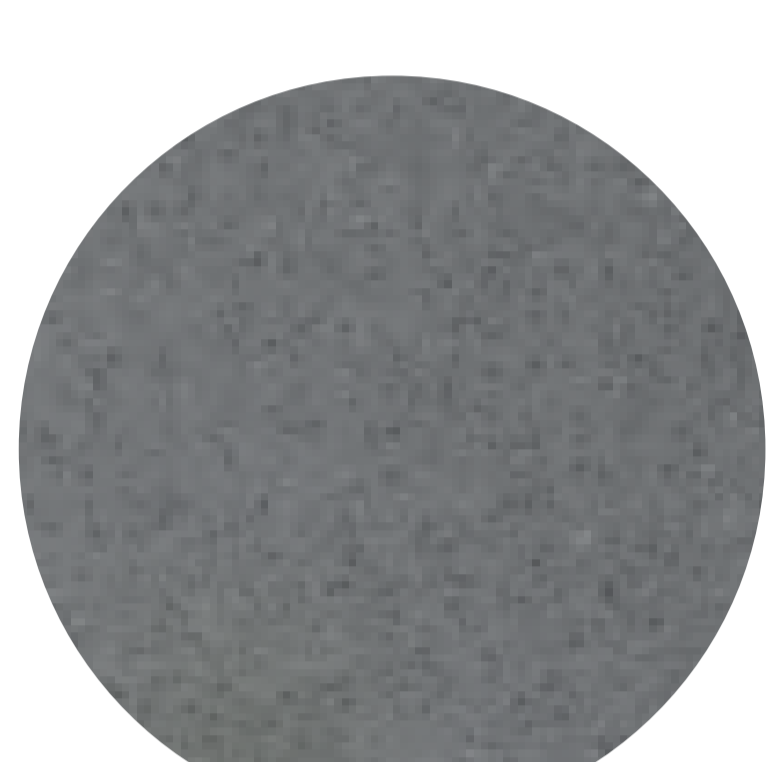

GREY SPARKLE QUARTZ



BLACK SPARKLE QUARTZ



RHELVINA

### LEATHER QUARTZITE COLLECTION

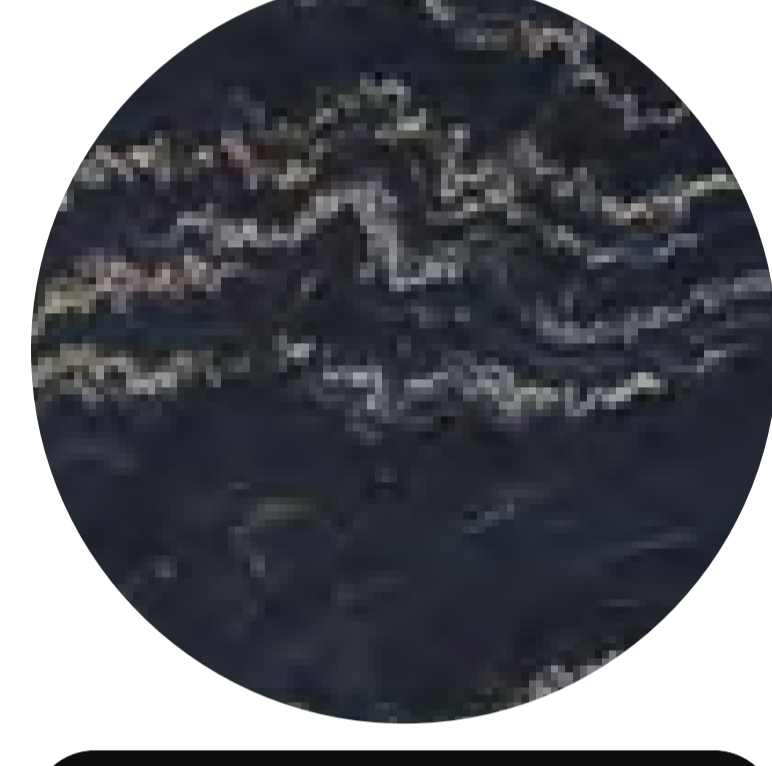

TITANIUM GOLD

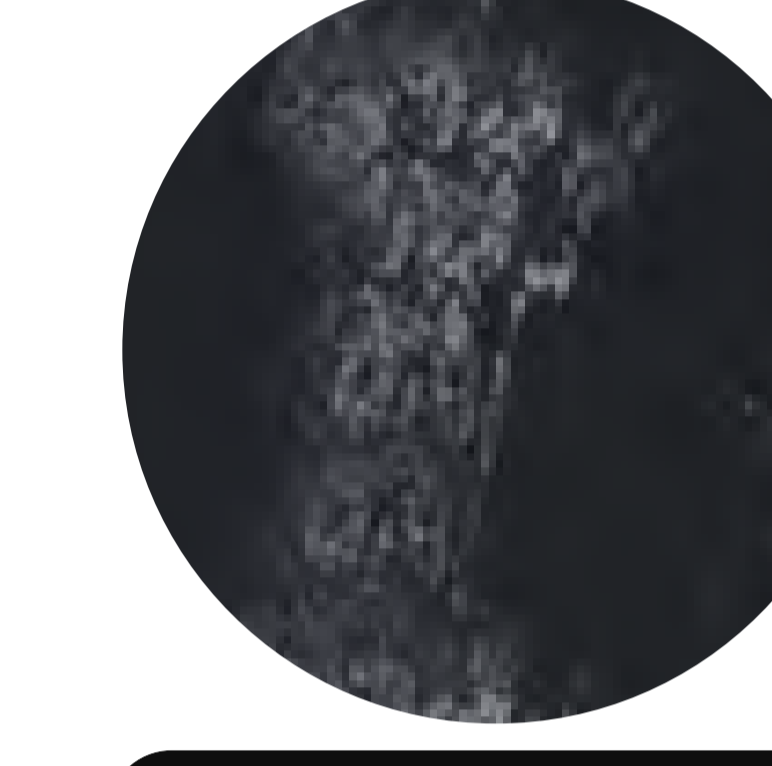

TITANIUM GALAXY

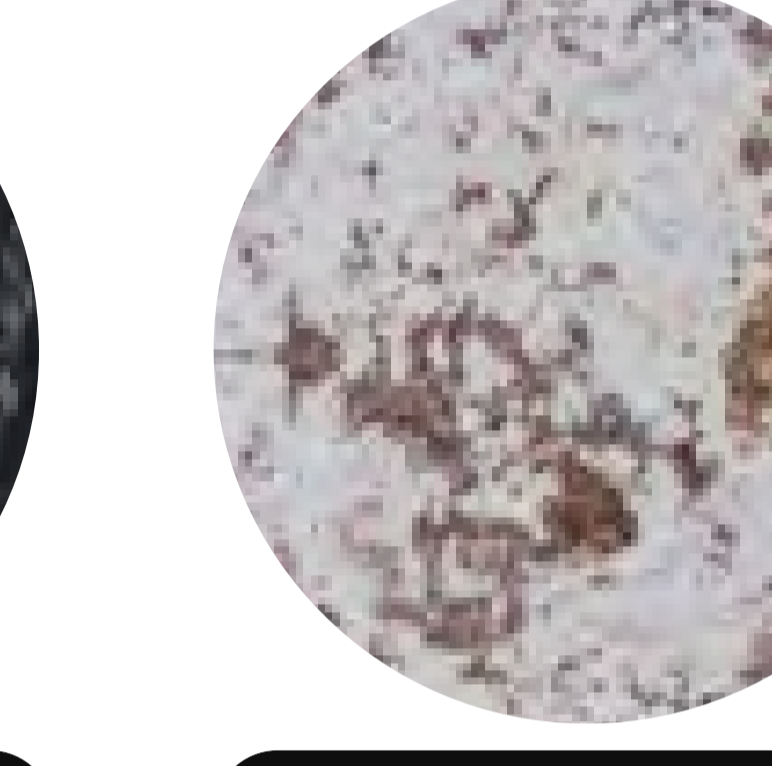

ROSIANA

## FEATURES

### SMART CONTROL



SMART APP & ALEXA

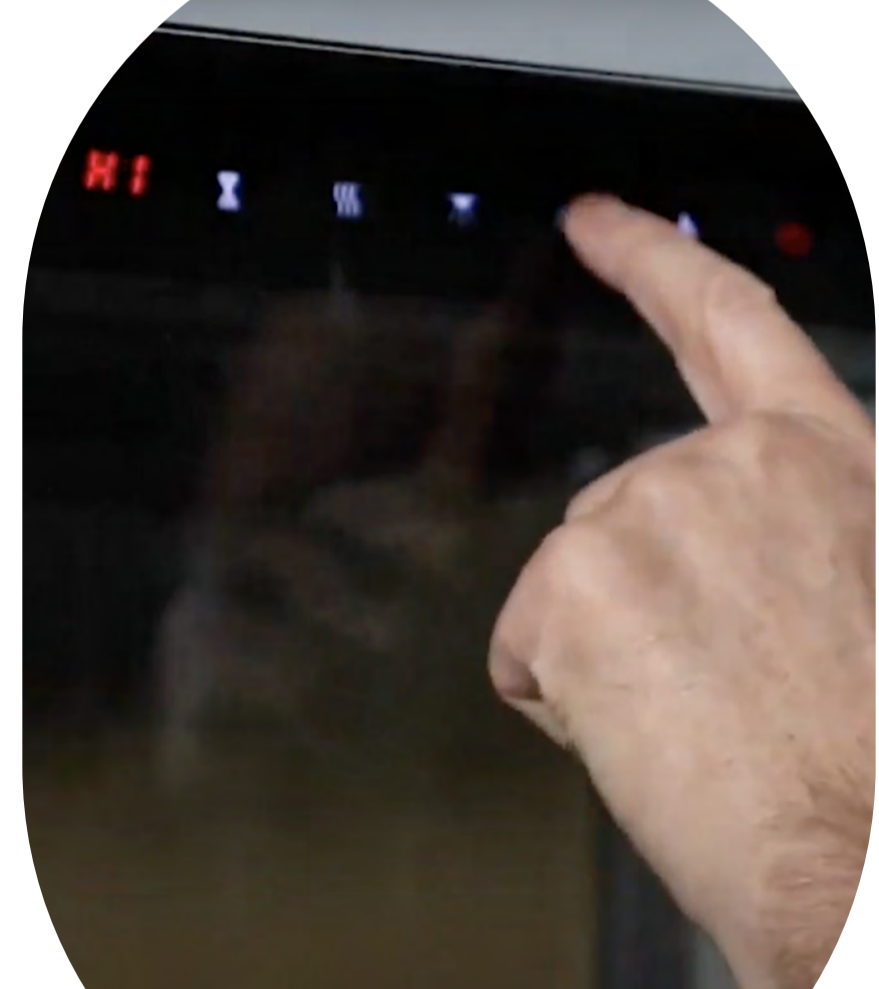

TOUCH CONTROL



LCD REMOTE

Step into the future, where convenience meets innovation. Take command effortlessly through the dedicated app, using the LCD remote control or the discreetly designed touch screen.

## MULTI-FUEL PACKAGE



### INCLUDES

- White Pebbles
- Ice Glass
- Charred Glass
- Smouldering Ember LED's
- Choice of logs - HD Logs or Upgrade to our British Woodland

### 10 YEAR WARRANTY

Experience peace of mind with our premium 10 year warranty exclusively offered by Bespoke Fireplaces Ltd for all of our electric fires.

Our dedicated service department, staffed by highly trained service administrators and engineers are always happy to help.



## BRITISH WOODLAND LOGS

The perfect finishing touch in the worlds most realistic electric fire, created with materials from nature itself. Starting with a trio to the fundamental fuel beds to recreate the essence of the forest floor; organic husk, green moss land and charred chippings create the base.



### LUXE

If you prefer a clean cut, engineered look, choose the Luxe.

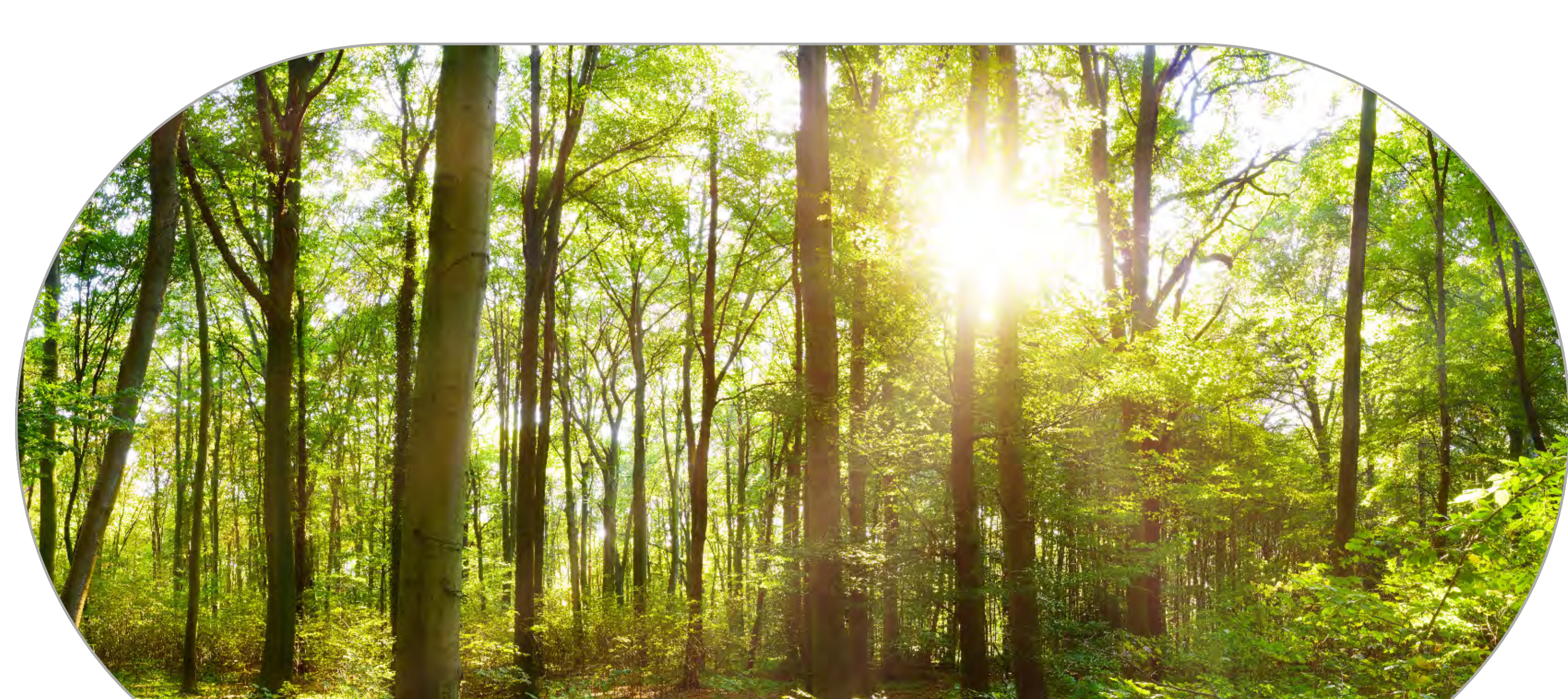

### OAK

For a more rustic campfire feel, the Oak logs are the perfect choice.

